



LD/LEEDeR SERIES DEHUMIDIFIERS

OPERATION AND MAINTENANCE MANUAL

Dectron.com

Table of Content

General Information	4
• Operating Safety	4
• Reference and Additional Information	5
○ Contact Us	6
• Special Considerations for Equipment Containing A2L Refrigerant	7
• Basic Information	9
○ Dehumidifier View and Options	9
○ Dehumidifier External Systems Connection	11
○ Dehumidifier Optional Arrangement	11
○ Pool Water Heating Options – Bonding	12
○ Air Conditioning Options – Outdoor Air Fluid Coolers	13
○ Equipment Specific Data	15
Layout and Components	16
• Dehumidifier Main Components	16
• Control System	19
• Outdoor Air Fluid Cooler Layout and Components	20
Sequence of Operation	22
• Set Points	22
• Ventilation	22
○ Purge Option	22
○ Heat Recovery Option	23
• Space Heating	23
• Air Conditioning, Dehumidification and Pool Heating	23
○ Economiser Mode Option	23
○ Compressor(s)	24
• A2L Refrigerant Mitigation	25
Interface and Communication	27
• Touch Display Operator Panel	27
○ Alarms	28
• Remote Communication	29
General Considerations for Any Work Performed on the Equipment	30
Basic Maintenance	32
• Routine Maintenance Program	33
• Specific Components Maintenance	34
Service, Repair, Commissioning and Decommissioning	36
Warranty	40

General Information

This manual provides basic information about the applicable dehumidifier and its operation.

- This manual covers details of the equipment of various design, size, capacity etc.; therefore, some details covered in this manual may not be relevant to each piece of equipment. Refer to your equipment's submittal documentation.

Important information regarding operation, maintenance, and start up is normally provided with the equipment and can also be obtained from the manufacturer – contact Customer Support Team as needed (see **Reference and Additional Information** below).

Operating Safety (Warnings, Cautions, and Notes)

FOR YOUR SAFETY: READ BEFORE PERFORMING ANY OPERATIONS, MAINTENANCE OR SERVICE TASKS!



- Only qualified technicians should install, operate, maintain, service, repair or decommission mechanical equipment including this appliance.
- Make sure to read this manual before performing any maintenance, service, repair or other related tasks to familiarize yourself with the equipment as well as with any potential hazards. Always exercise caution!
- This equipment is not intended for use by persons (including children) with reduced physical, sensory or mental capabilities, or lack of experience and knowledge, unless they have been given supervision or instruction concerning use of the appliance by a person responsible for their safety. Children should be supervised to ensure that they do not play with the appliance.



Beware of electrical power and high electrical voltage!

- Follow proper safety procedures – lockout, tagout, and other respective procedures
- Failure to follow safety procedures can result in serious injury or death



Beware of moving parts and hot surfaces!

- Make sure to stop all moving parts (fans, blowers, etc.) before accessing the equipment's internal space
- Be aware of hot surfaces (hot refrigeration, space heating pipes, coils, heaters, etc.)



Beware of specific hazards - high pressures, flammability and chemicals!

- Dehumidifiers, equipped with compressors, contain refrigerant under high pressure; oil is also contained in the compressor and refrigeration circuit(s). Some dehumidifiers may also contain other liquids such as glycol mixtures and pool water.



- A2L group refrigerant, used in compressor(s) circuit(s), is classified as mildly flammable!
- Be aware that refrigerant may not contain an odour.

The following warnings, cautions, and notes appear throughout this manual and referenced documentation whenever special care must be taken to avoid potential hazards that could result in equipment malfunction or damage, personal injury, or death.

 **WARNING**

Indicates a potentially hazardous situation which could result in serious injury or death if handled improperly.

 **CAUTION**

Indicates a potentially hazardous situation which could result in moderate injury or equipment damage if handled improperly.

Note

Indicates a situation that could result in equipment damage or improper/ineffective operation if handled improperly.

Reference and Additional Information

For safe, efficient and problem-free operation, it is critical to handle the dehumidifier (as well as related systems and components) properly at each step - from receiving and storage to installation and start up. Relevant information can be found in the respective documents (like **Installation Manual**) provided with the dehumidifier.

This manual and other related document could be obtained from the manufacturer (see **Contact Us** below).



WARNING! Any work on the equipment (dehumidifier, outdoor condenser, fluid cooler, etc.) must be performed in accordance with respective manufacturer recommendations as well as submittal documentation, national and local Codes and Regulations, and appropriate field practices. Failure to do so could result in personal injury, equipment damage or malfunction, and will void equipment warranty.

**WARNING!****General Precaution**

Do not use means to accelerate the defrosting process or to clean, other than those recommended by the manufacturer.

The appliance shall be stored in a room without continuously operating ignition sources (for example: open flames, an operating gas appliance or an operating electric heater).

Do not pierce or burn.

Be aware that refrigerants may not contain an odour.

Attention: Maintenance Team

CAUTION. To ensure equipment longevity and proper and efficient operation, the dehumidifier and its auxiliary systems and devices (outdoor condenser, fluid cooler, boiler package, etc.) should be maintained properly and regularly. Failure to do so could negatively affect premise comfort levels and people's health. It could also lead to equipment damage, malfunction, premature wear and tear and may void equipment warranty.

Personnel Training and Qualification

Personnel, performing such work tasks (installation, maintenance, service, repair etc.) must be qualified for such tasks, which includes (but not limited to) training and possessing knowledge of respective tasks and procedures.

Since the dehumidifier (equipped with compressor(s)) contains class A2L (mildly flammable) refrigerant, following knowledge is critical to have for **ALL PERSONNEL** performing **ANY OF THE TASKS**:

- Information and understanding of the explosion and ignition potential of FLAMMABLE REFRIGERANTS
- Information about POTENTIAL IGNITION SOURCES,
- Information about the ventilation of the equipment, its compartments and the room it's installed in, and its effect on the safety (of the surroundings, carried out work tasks etc.)
- Information about refrigerant detectors (principle of functioning, interaction with the equipment, specific procedures related to refrigerant detectors – how to check, replace, repair and disable it etc.)
- Information and understanding of the concept of sealed components and enclosures.
- Information about correct work procedures for specific tasks, related to **MAINTENANCE, SERVICE, REPAIR, COMMISSIONING and DECOMMISSIONING**. These tasks include (but not limited to):
 - Commissioning – verify/check that:
 - conditioned space area is sufficient per refrigerant charge of the appliance.
 - Leak test is performed and is satisfactory
 - Appliance safeties are ok.
 - Other relevant safety and installation requirements are met
 - Maintenance-related (also – refer to separate chapter “Basic Maintenance”):
 - Verify that sufficient ventilation/airflow is in place
 - Be aware of the equipment operation/malfunction possible relation to its charge
 - As/if needed, perform proper capacitor discharge not to cause any sparks
 - As/if needed replace sealed or intrinsically safe components
 - Check appliance safeties
 - Repair/Service/Decommissioning-related – in addition to listed above for MAINTENANCE:
 - As/if required – perform brazing and other auxiliary tasks (recovery, pressure testing, vacuuming, purging etc.) following best field practices, accounting for flammability of the refrigerant. Refer as needed to separate chapter “Service, Repair and Decommissioning”
 - If safety of decommissioned and to-be-removed equipment is affected by presence of the refrigerant in it – remove refrigerant prior.

In addition to qualifications outlined above, for personnel, performing some INSTALLATION, SERVICE, REPAIR and DECOMMISSIONING tasks (related to install, repair and/or disposal of mechanical and refrigeration equipment, ductwork, piping, electrical), formal training in respective field and/or trade licensing may be required, issued by local or national authorities.

Contact Us

Seresco
5685 Rue Cypihot,
Saint-Laurent, QC H4S
Canada
SerescoDehumidifiers.com

1-833-DAS-POOL (327-7665)

Schedule / Modify a Start-up:

Startups@DehumidifiedAirServices.com

Inquire about Warranty:

Warranty@DehumidifiedAirServices.com

Order Parts:

Parts@DehumidifiedAirServices.com

All Other Product Support:

Support@DehumidifiedAirServices.com

Special Considerations for Equipment, Containing A2L Refrigerant

Attention: Equipment Containing A2L Refrigerant



CAUTION! Dehumidifier, equipped with compressors, contains A2L (mildly flammable) group refrigerant. Such equipment placement shall satisfy certain requirements of local and national Codes and Regulations, such as **UL 60335/SCA B52/ASHRAE 15** and others, as applicable.

Review following chapter in detail prior to placement of the equipment to ensure the requirements are met.

To ensure that A2L-containing equipment is safe, multiple mitigation systems and approaches are used; that includes among others, specific relationship between refrigerant charge of the dehumidifier, ventilation operation and size of space, conditioned by the dehumidifier, as well as other mitigation means (leak detection system etc.)

Dehumidifier Refrigerant Charge, Conditioned Space and Airflow Relationship

One of the mitigations means is to ensure that airflow, maintained by equipment, and conditioned space are adequately and mutually sized for proper venting and dilution of the air containing refrigerant (in case of the leak).

Table 2 establishes relationship between refrigerant circuit charge (**Mc**), total conditioned space area (**T_{Amin}**), and the equipment airflow, per respective model/option:

- The conditioned room space, served by the dehumidifier must have area not less then **T_{Amin}** (see **Table 2**)
 - To account for building's ground level altitude, **T_{Amin}** should be adjusted by adjustment factor (**AF**): multiply **T_{Amin}** value from **Table 2** by **AF** value from **Table 1**.
- Two airflow values are specified to be maintained in the event of refrigerant leak:
 - Total airflow, established by dehumidifier, must be not less then **Q_{minTA}**
 - Airflow, venting the compressor compartment, must be not less then **Q_{minV}**
- **Mc** value shows (per UL 60335-2-40) system total refrigerant charge for dehumidifier with single compressor circuit, or largest single circuit charge, for dehumidifier with multiple compressor circuits.

NOTE: Refer to the equipment **Operation and Maintenance Manual** for the details on the dehumidifier ventilation operation and other operational aspects!

Table 1. T_{Amin} adjustment factor for building site ground altitude.

Halt, m	0	200	400	600	800	1000	1200	1400	1600
AF	1.00	1.00	1.00	1.00	1.02	1.05	1.07	1.10	1.12
Halt, m	1800	2000	2200	2400	2600	2800	3000	3200	
AF	1.15	1.18	1.1.21	1.25	1.28	1.32	1.36	1.40	

Table 2. Conditioned Space and Airflow Relationship

Model	LD 092/102/112	LD 152	LD 162	LD 182	LD 182/212
Mc , kg	14	16	18	20	25
Q_{min} , m3/h	1418.9	1621.6	1824.3	2027	2533.8
T_{Amin} , m2	43	49.1	55.3	61.4	76.8
Q_{minV} , m3/h	326.7	373.3	420.0	466.7	583.3
Model	LD 252	LD 282	LD 322	LD 362/412/482	
Mc , kg	30	32	36	40	
Q_{min} , m3/h	3040.5	3243.2	3648.6	4054.1	
T_{Amin} , m2	92.1	98.3	110.6	122.9	
Q_{minV} , m3/h	700.0	746.7	840.0	933.3	



Dehumidifier Internal Refrigerant Detection System (RDS)

Dehumidifier, that contains A2L refrigerant, is equipped with internal Refrigerant Detection System (RDS) to ensure safety in event of the refrigerant leakage during equipment operation or idling (this feature requires dehumidifier to be powered). For detailed info on RDS – refer to sub-chapter “Refrigerant Detection System”.

Basic Information

Dehumidifier View and Options

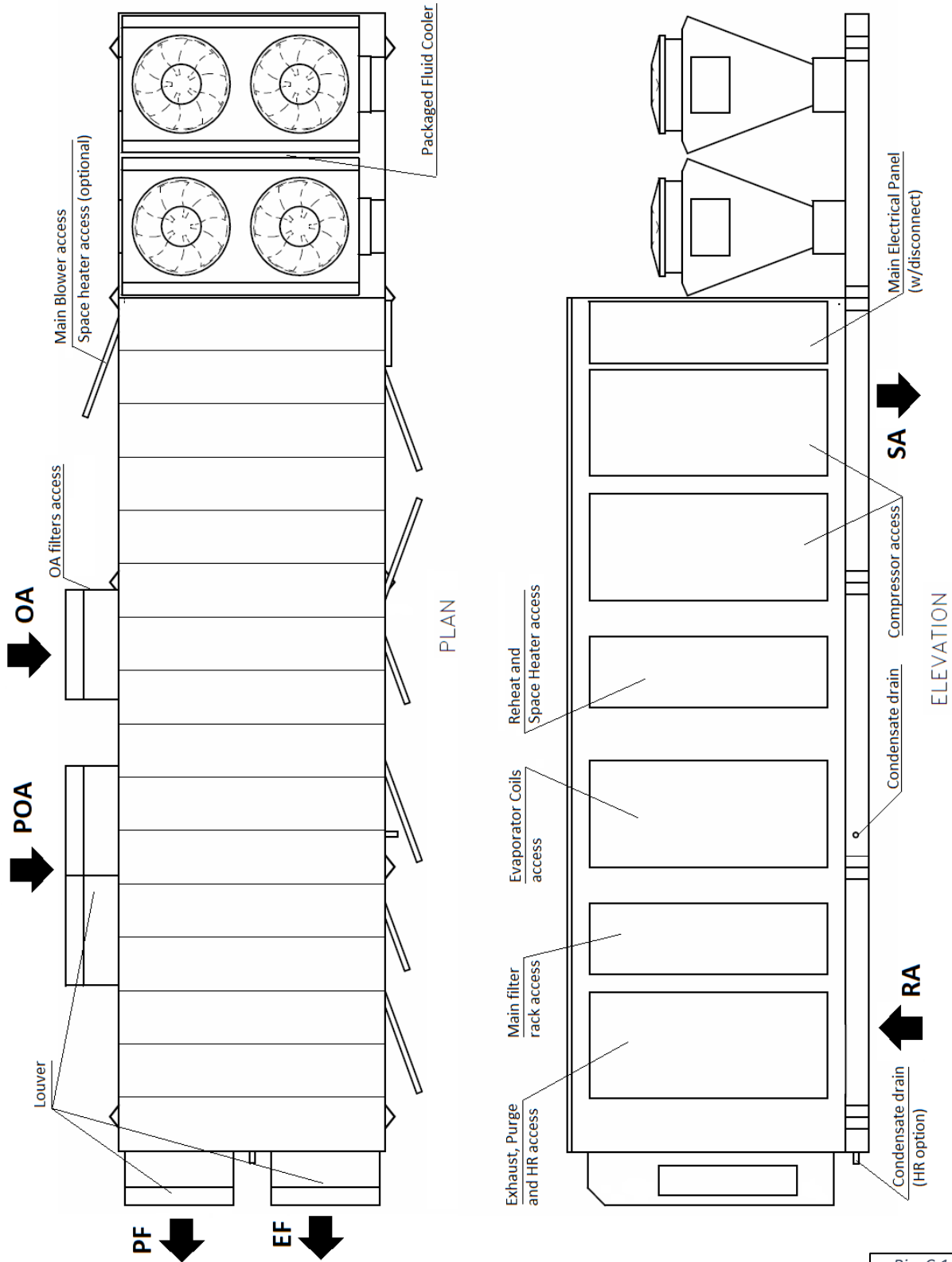

Pic. C.1

Standard dehumidifiers of this series are semi-custom: while basic concept and layout is the same, options and specific systems and components layout and location may vary from one dehumidifier to another. One of the typical dehumidifier arrangements is shown on Pic.C.1.

Dehumidifier Options

- Indoor or outdoor installation.
 - *Note:* Pic. C.1. shows outdoor model, equipped with louvers (to protect air intake and discharge openings from elements). Indoor model would have ducts connected to respective openings; no louvers would be needed.
- Capacity (number of compressors) – two to three compressors (see **Dehumidifier Optional Arrangement** below for more details):
 - Two-compressor dehumidifier option (18 to 80 tons).
 - Three-compressor dehumidifier option (90 to 100 tons).
- Airflow/ductwork connection *. Pic. C.1 shows some options only; each option location availability depends on the dehumidifier installation (indoor or outdoor) and other options:
 - **Return Air (RA)** ductwork connection - top, bottom, end, sides.
 - **Supply Air (SA)** ductwork connection – top, bottom, sides.
 - Optional **Min Outdoor Air (OA)** ductwork connection/termination – top, sides.
 - Optional **Min Exhaust Fan (EF)** and **Purge Fan (PF)** ductwork connections/terminations – end, sides.
 - Optional **Purge Outdoor Air (POA)** ductwork connection/termination - top, sides.
- Optional Pool Water Heating **.
 - Dehumidifier can accommodate up to two pool water heating circuits
- Optional Space Heating - hot water coil, electric or gas heater ***.
- Optional Heat Recovery (HR) circuit.
- Air Conditioning (AC)* – external water cooling or fluid cooler (packaged or separate).
 - *Note:* Pic. C.1 shows outdoor model with “packaged” fluid cooler (mounted with the dehumidifier). “Packaged” AC option is available for outdoor models only; alternatively, indoor and outdoor models could be fitted for separate/remote AC option – remote fluid cooler or other external cooling media source.

* *Some available options (tonnage, ductwork connections, AC options etc.) are shown. Refer to the submittal and other relevant documentation for your dehumidifier’s options.*

** *The pool water heating option relies on compressor-created excess heat and is used as an additional heating source. It does not eliminate the need for a main pool water heater.*

*** *For specific details on space heating (hot water, gas, electric) option, refer to the submittal and other documentation:*

- **Gas-fired duct heater** can be installed internally (fitted inside the dehumidifier at the factory) or provided for field installation (to be fitted in the supply air ductwork).
- **Electric heater** or **hot water coil**, depending on capacity, model, size, etc., can be installed externally (mounted on the top of SA opening or fitted in the supply air ductwork) or internally. Refer to your dehumidifier’s submittal documentation.

Attention! Equipment Clearances and Dimensions!

 **CAUTION!** For equipment proper operation, maintenance and service, respective clearances should be maintained. Generally, 30” clearances to the equipment must be kept for the maintenance and service purposes. For the specific required clearances information, as well as dehumidifier overall dimensions, distances to pipe connections, duct connections etc., refer to the submittal documentation.

Dehumidifier External Systems Connection

Pic. C.1 shows provisions for external systems connections, including ductwork, electric power and control wires and various piping connections.

CAUTION! Current manual shows general/default connections' location. For details regarding specific dehumidifier's connections (actual location, piping sizes and position dimensions, circuit type and flow direction etc.), refer to the dehumidifier's submittal documentation as well as dehumidifier's labels and stickers.

- ✓ Except for the condensate, all other piping systems are optional and may not be present in each dehumidifier

- **Condensate Drain Line** – bottom, side (through the dehumidifier base).

NOTE. Dehumidifier **MUST** be equipped with a P-trap at the condensate connection for proper operation! If dehumidifier is requested from the factory without P-trap, one **MUST** be installed on site prior to dehumidifier being commissioned. Refer to the **Installation Manual** for details.

- **Air Conditioning (AC) Connection.**
 - **Packaged AC option** (outdoor dehumidifier with outdoor fluid cooler (O AFC) incorporated with the dehumidifier), does not require piping connection to external AC system or device.
 - *Pic 1.C. shows packaged outdoor model with O AFC mounted at the end of the dehumidifier; alternatively, if requested, O AFC could be mounted on the roof of the dehumidifier.*
 - **Remote ("split") AC option** (indoor or outdoor dehumidifier, connected to external cooled water/glycol system or remote fluid cooler) – side or end (through the compressor compartment wall) connection.
- **Pool Water Heating** – bottom, side.
- **Space heating (Hot Water connection)** – bottom, side.
 - Some connection location options for both, pool and space, heating pipe lines, are limited to indoor installation only – refer to submittal documentation
- **Space Heating (Gas Heater connection, gas line).** If the dehumidifier is equipped with a gas heater (boiler, gas furnace etc.) for space heating purposes, the **gas** line connection is to be brought to the gas heater directly.

 **WARNING! Gas Line.** The gas line must be installed in accordance with respective device documentation (boiler, furnace, etc.) and local codes and regulations.

- **Electric Power and Control Connection.** Electric power is normally brought to the dehumidifier disconnect, normally incorporated with main electric panel (see Pic. C.1). If dehumidifier is not equipped with the disconnect, power lines to be brought directly to the main electric panel.

Dehumidifier Optional Arrangement.

Multi-Compressor Arrangement and Compressor Compartment Layout

NP series dehumidifier, depending on required capacity, could have two, three or four compressors. Pic.C.2 shows options of dehumidifier supply air (SA) end and compressor compartment arrangement, based on number of compressors.

Pic.C.2 shows top supply air (SA) connection option as an example – other connection options are available also.

For two-compressor dehumidifier, compressor compartment may have side (Fig.1; same as dehumidifier, shown on Pic. C.1) or end (Fig.2) location. End location is mostly used in higher capacity dehumidifiers.

Three -compressor dehumidifiers (Fig.3) normally have end location of the compressor compartment.

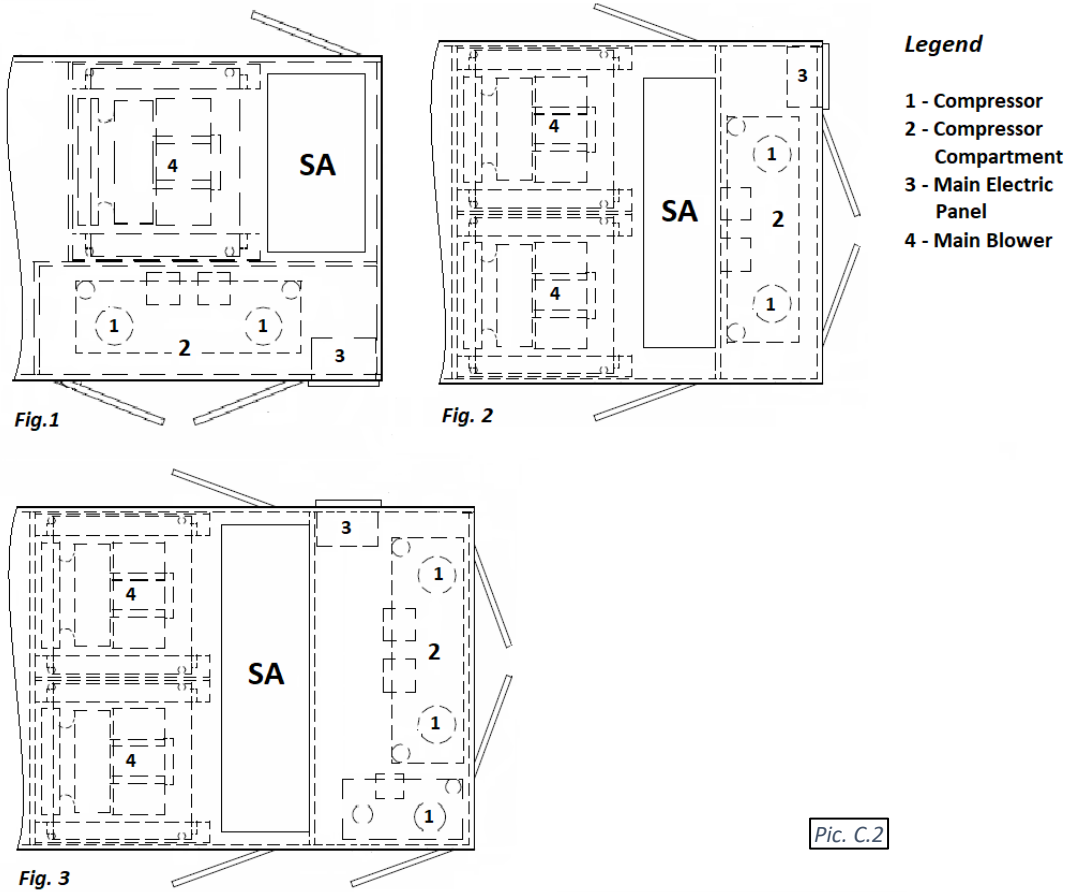

Pool Water Heating Option – Bonding

Pool Equipment Bonding

The dehumidifier shall be bonded to the pool bonding and grounding system through the wiring lug installed for this purpose (example shown in the picture next page). One side of the lug is connected internally to the pool water heat exchanger. This allows the dehumidifier to be part of the pool equipotential bonding system and prevents pool water heater corrosion.



⚠️ WARNING! Pool equipment bonding. Failure to properly bond the dehumidifier’s pool water heat exchanger may cause failure which will not be covered under warranty.

Air Conditioning Options – Outdoor Air Fluid Coolers (O AFC).

Basic views of standard air conditioning options are shown on Pic.C.4 (below). Note, that depending on number of factors, dehumidifier may have different fluid cooler provided with it - refer to the dehumidifier's submittal documentation for more details.

Standard fluid coolers used with current series of dehumidifier is NG-V series, composed of number of "two-coils-two-fans" blocks, based on required capacity of the cooler:

- Fluid cooler NG-V-12 (Pic.C.4, Fig.1) is composed of one such block; NG-V-22 (Fig.2) composed of two such blocks etc. largest single fluid cooler, NG-V-62 (Fig.3) composed of six of them.

As an option, each block of fluid cooler could be equipped with the pump package (as shown on Fig.1 for NG-V-12).

Attention! Equipment Clearances!

Proper clearances should be maintained for adequate airflow and heat rejection! Generally, up to 36" side and 96" top clearances are required. For more information on clearances as well as equipment dimensions and other details, refer to the submittal documentation.

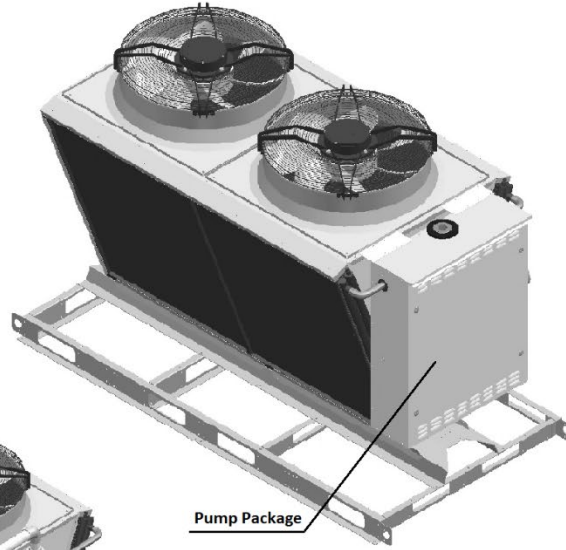

Fig. 1

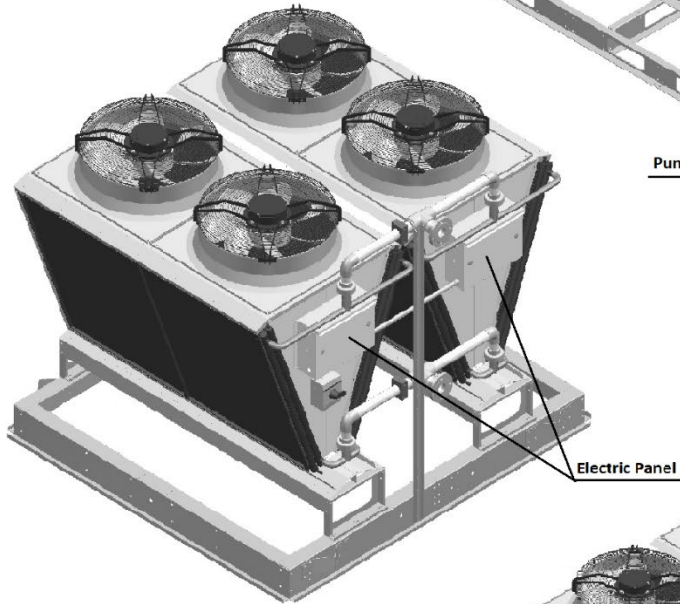

Fig. 2

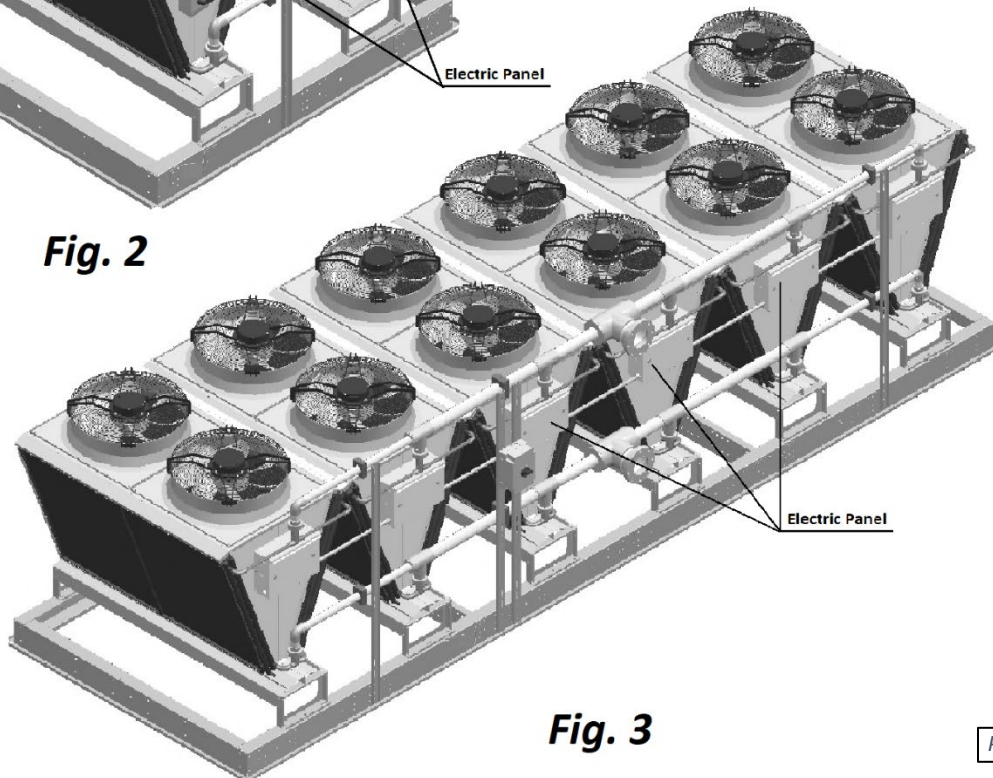

Fig. 3

Pic. C.4

Equipment Technical Data

Detailed information about specific equipment is presented in submittal documentation; some general info is provided below:

Air Data	ESP Min	0.5" wc
	ESP Max	3" wc
	Leaving Air Temperature max	120 F
Heating Water Data	Pressure, MAX	250 psi
	Entering Water Temperature MAX	180 F
Pool Water Data	Entering Water Temperature MAX	94 F
	Leaving Water Temperature MAX	104 F
Fuses Data For amperage rating of specific fuse – refer to Wiring Diagram provided with the equipment	Class	J, CC
	Type	Time-delay
	V (rated)	600 VAC, 300 VDC

Specific information for individual dehumidifiers is provided in the following methods:

Main Label (Pic. C.5): the manufacturer tag attached to the front of the dehumidifier includes the dehumidifier's most critical data:

- ✓ General data including:
 - Serial number
 - Dehumidifier model (nomenclature)
 - Design room conditions (air temperature and humidity)
- ✓ Operational data, including:
 - Refrigeration (refrigerant type, charge, etc.)
 - Electrical/airflow (dehumidifier voltage, CFM, etc.)
 - Other applicable data (pool heating, space/auxiliary heating features, etc.)

General Data				
Serial Number : 16091815				
Unit Model : NE-004-PB-X-P3NB1162G2C4AD3				
Condenser Model : NC-B-1V-CUC-S				
Application : OUTDOOR USE				
Design Room Conditions : 75 °F 54 % R.H.				
Refrigeration Data				
Refrigerant Type : R410A				
Factory Charge (CKT 1) :		21 lbs	Oil Charge (CKT 1) : 11 oz POE	
High Pressure Cutout (Switch) :		600 psig		
Low Pressure Cutout (Switch) :		50 psig		
Electrical & Airflow Data				
MCA (Minimum Wire Size) :		30.0	Use Copper Conductors Only	
MOP (Max Fuse or CKT BKR) :		45.0	System Voltage : 208/3/60	
(IACR type NEC)				
	Qty	Voltage	CFM	HP
Supply Motor :	1	208/3/60	1600	2.2
Outdoor Air Intake :	-	-	400	-
OACC Blower Motor :	1	208/1/60	-	0.6
Gas Heating Package :	1	-	-	-
	Qty		LRA	RLA
Compressor Motor :	1		123.0	17.6
Pool Heating Data				
Pool Water Flow (Total) :		7.0 GPM	Pressure Drop : 3.0 psi	
Max. Inlet Pressure :		60.0 psi	Connection Size : 0.75 NPT	
Auxiliary Heating Data				
Gas Heater Output :		80 MBH	Gas Connection Size : 0.75 NPT	
Gas Pressure Input (Min/Max) :		7.0 / 14.0 in-H2O		
Boiler Loop Capacity : 7 U.S. Gal. 33% Propylene Glycol				

Pic. C.5

Note: The main label shown above is just an example.

Labels and Stickers: attached when applicable to the exterior and interior of the dehumidifier to show:

- ✓ External systems connections location/direction (pool/space heating, cooling circuits, condensate)
- ✓ Air filter locations, quantity, and size.
- ✓ Additional Info (warning, caution stickers, etc.)

Wiring Diagrams: attached to the interior side of the dehumidifier, depict dehumidifier control and power wiring.

Remotely installed condenser or cooler would have its specific information provided in similar manner (labels etc.).

Attention! Glycol Circuits.

Unless otherwise indicated, equipment fluid circuits (except for refrigeration and pool water circuits), are normally filled/to be filled with water/glycol mixture; normally, rust inhibitor-infused food-grade propylene glycol is used. Glycol mixture concentration is normally shown on Main Label – refer as needed.

Layout and Components

The general layout and components location is the same for all dehumidifiers of current type, however some may vary, based on the dehumidifier's specific options – refer to submittal documentation. Pic. D.1 below shows all/most available options, some of which may not be present on your dehumidifier.

Dehumidifier Main Components

- **Main Blower (1)** is in the main blower compartment behind or next to the **Compressor Compartment (3)** with **Main Electric Panel (2)**. Based on airflow requirements, number of main blowers may vary (up to four).
 - Two blowers could be installed either side by side or stacked on a top of each other (Pic. D.1A); four blowers' arrangement would have two stacks, shown on Pic. D.1A, installed side by side.
- **Min Outdoor Air (OA) Opening (4)** has a motorized damper and filter(s). The **Manual OA Damper (5)** is usually used to set proper amount of outdoor air intake; in some cases, it could be equipped with modulating actuator for automatic adjustment of outdoor air intake.
 - Outdoor-installed dehumidifier would have **louvers (76)** installed at the OA opening.
- **Min Exhaust Fan(s) (EF) Assembly (6)** (fan and motorized damper) is located on the dehumidifier's return air side; Exhaust Air opening in outdoor-installed dehumidifier is equipped with **louvers (76)** also.
 - Min Exhaust Fan Assembly is hinged and could be opened for better access to the fan electric box.
- Dehumidifier, equipped with **Heat Recovery (HR)** option, would have **HR glycol coils (71)**, installed at the **Min Exhaust (EF)** and **Min Outdoor Air (OA)** openings, and **HR pump (72)**, installed in return air compartment.
 - If HR option is present, **Min Exhaust Fan Assembly** would normally be equipped with a filter rack.
- If dehumidifier is equipped with **Purge** option, additional **Purge-exhaust fan(s) (PF)** (73) with motorized damper would be installed on dehumidifier's return air side, as well as additional ("**Purge**") **Outdoor Air (POA)** (74) opening(s), equipped with motorized dampers, would be located directly upstream of **Main Filter Rack (9)**. Motorized **Return Air (RA) damper (75)** would be located between return air side and POA opening(s).
 - Outdoor- installed dehumidifier would have **louvers (76)** installed at the **Purge-exhaust fan** and **Purge Outdoor Air** openings.
- Refrigeration **Evaporator** coils (7) and water/glycol **Reheat** coils (8) are located directly downstream of the **Main Filter Rack (9)**.
 - Motorized **Evaporator Bypass Damper (10)** is located next to the evaporator coils; it by-passes portion of air around evaporator, thus adjusting compressor circuit operation. Some dehumidifiers, based on airflow requirement, could be equipped with additional manual by-pass damper also.
 - Each compressor circuit has its own evaporator coil(s) set (one or two coils per circuit, depending on capacity), while all reheat coils, generally, are manifolded together and serve both compressor circuits together.
- **Space heater** location, if the dehumidifier is equipped with one, depends on the heater type:
 - **Hot water coil** or **Electric heater (11a)** is usually located directly downstream of the **reheat** coil;
 - **Gas heater (11b)** is usually located downstream of the main blower(s).

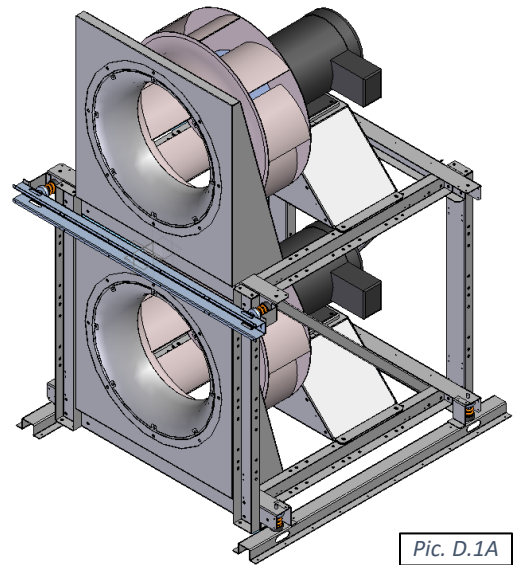

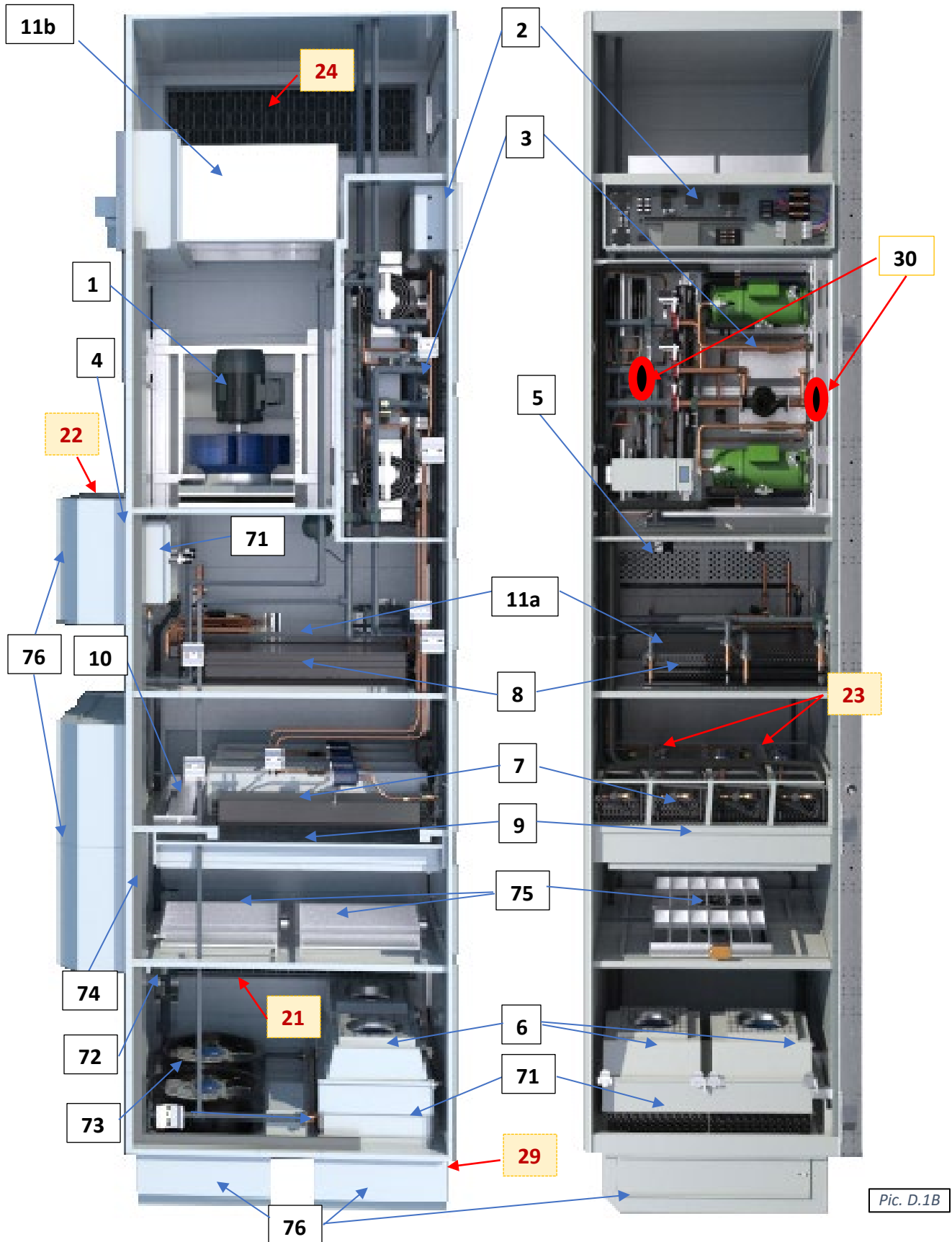

Compressor Compartment and Main Electric Panel (detailed; see Pic.D.1C).

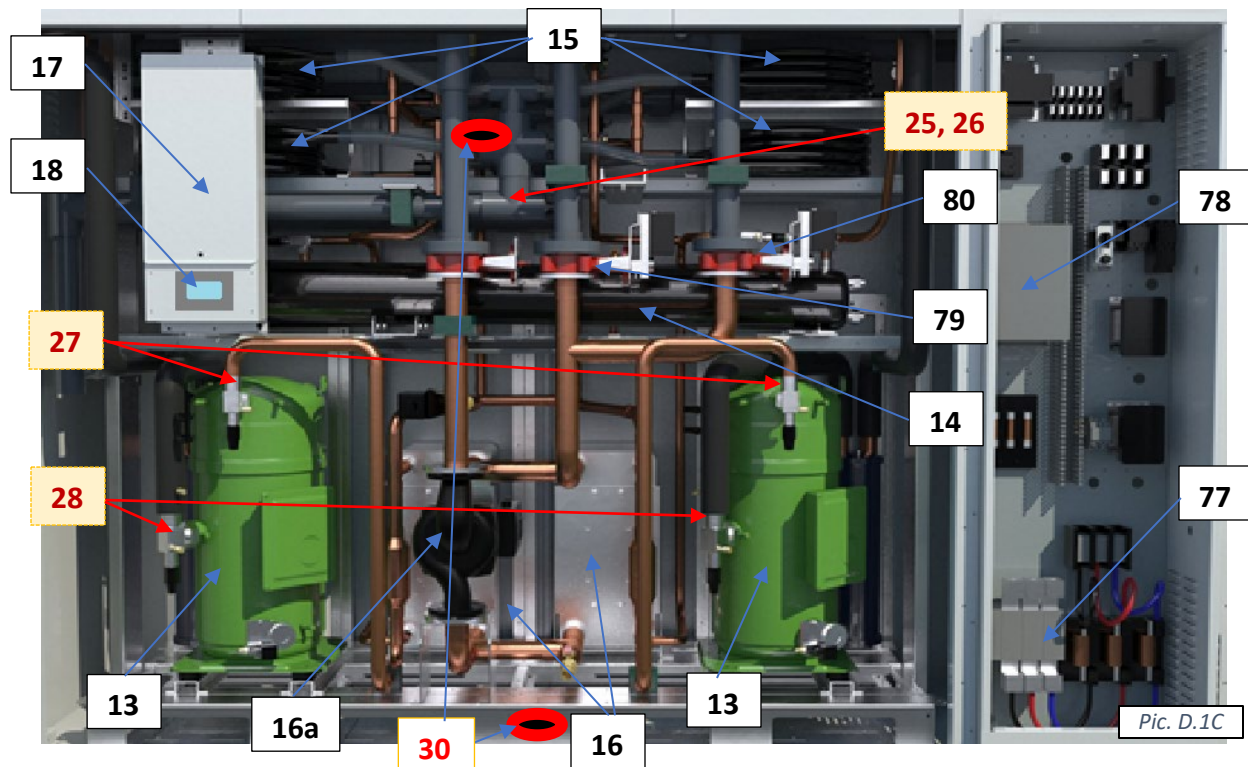

- **Compressor(s) (13), Receiver(s) (14)** and other components are located within the **Compressor Compartment (3)**:
 - Each compressor circuit has glycol-to-refrigerant **plate heat exchanger (16)** and, common to both circuits, **glycol pump (16a)**, that circulates water/glycol to reject compressor-generated heat.
 - Motorized water/glycol **Reheat (79)** and **AC (80) valves'** opening position determines how much fluid is diverted to respective coil(s) (reheat and fluid cooler or external heat sink).
 - If the dehumidifier has the standard **pool water heating** option, the compressor circuit additionally includes the **coaxial pool water heat exchangers (15)** and refrigeration pool water heating solenoid valves. Number of pool water heat exchanger varies based on dehumidifier type and capacity.
- Control sub-panel with **Main Control Board (17)** and **Operator Panel (18)** is normally mounted on the compressor stand frame.
- **Main Electric Panel (2)** contains main blower(s) **VFD (variable frequency drive) (78)**, main **Disconnect (77)**, if one is installed, and other electrical and control components (contactors, fuses, control transformer etc.).
- Packaged **Outdoor Fluid Cooler (19)**, if dehumidifier is equipped with it, is normally mounted at the end of the dehumidifier, adjacent to compressor compartment/supply air end (see Pic. D.1D).

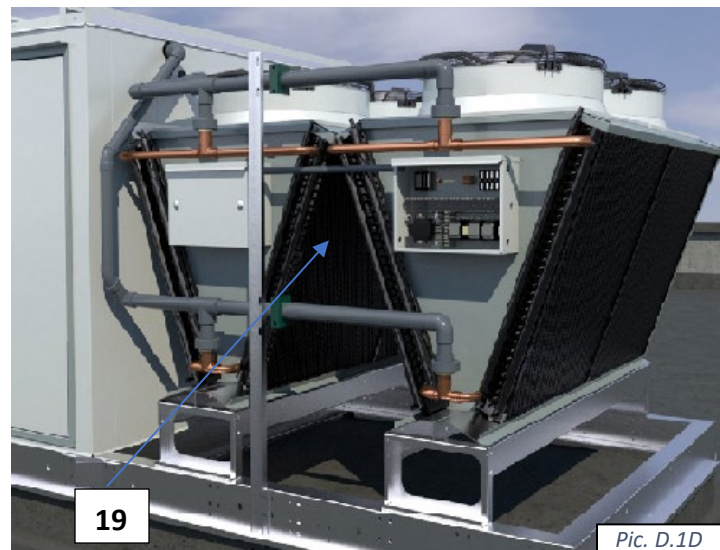

Control System

The dehumidifier control system is composed of sensors, spread throughout the dehumidifier, **Main Control Board**, **Operator Panel** and other electric components, located in the **Main Electric Panel**.

Temperature Sensors (Pic. D.2):

- a) **Temperature** sensors (thermistors) are used to monitor various temperatures (air, water, compressor, etc.);
- b) **Combo** sensor is used to monitor air temperature and humidity.

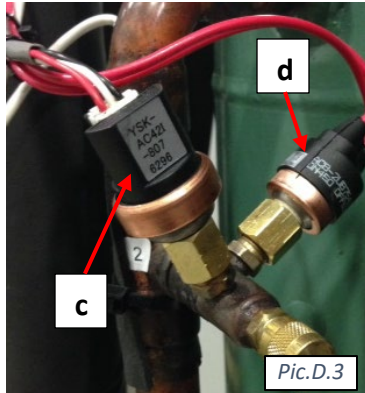

Compressor operation is monitored with **pressure sensors** (Pic. D.3):

- c) **Pressure Transducers** (as main operational control and safety) and
- d) **Pressure Switches** (fast-reacting backup safety).

Note. Sensors and safeties approximate location is shown on Pic. D.1B and D.1C – refer as needed.

- **RA Combo Sensor (21)** measures temperature and humidity of the pool room air (Return Air) entering the dehumidifier. It is located at the return air ductwork connection to the dehumidifier.
- **OA Temperature Sensor (22)** measures outdoor air temperature; it's located at the OA filter rack.
 - As an option, the combo sensor (instead of regular thermistor) can be installed at the OA intake to measure both the temperature and humidity of the outdoor air.
- **ET (EvapT) Temperature Sensor (23)** measures the temperature of air leaving evaporator coil. It's located directly downstream of the evaporator coil(s) (one sensor per each compressor circuit).
- **SA temperature sensor (24)** measures the temperature of the air leaving the dehumidifier (supplied to the premise). It must be located downstream of the space heater:
 - SA temperature sensor of dehumidifier, equipped with gas heater, would be composed of four regular temperature sensors, installed in different points at supply duct connection, averaging temperature reading.
- If the dehumidifier is equipped with the pool heating option, the **Pool Water Temperature sensors (Pool In (25) and Pool Out (26))** measure the entering and leaving pool water temperature. The sensors are located at respective manifolds.
 - As an option, the pool water heat exchanger piping/manifold may have water flow switch also.
- The compressor's discharge line (high pressure side) is equipped with **Temperature and Pressure sensors set - Discharge Temperature Sensor, High Pressure Transducer and High Pressure Switch (27)** - to protect the compressor and control its operation. A similar function is performed by **Suction Temperature Sensor, Low Pressure Transducer and Low Pressure Switch (28)** located at compressor's suction line (low pressure side).
 - Said safeties/sensors are installed on each compressor.
- If dehumidifier is equipped with **Heat Recovery** option, it could also have **Exhaust Air (EA) Temperature Sensor (29)**, installed downstream of exhaust-side located heat recovery glycol coil.
- Dehumidifiers, containing A2L refrigerant, are equipped with **Refrigerant Detection System (RDS) (30)** - a network of **Refrigerant Sensors** (Pic.D.4), placed through out the dehumidifier to detect refrigerant leak and trigger mitigation measures (see chapter "Sequence of Operation" for more details).

- Refrigerant Sensors are located within the compressor compartment; exact quantity and location may vary per dehumidifier, dependent on its size and configuration, but typically sensors would be located closer to the floor/bottom of the equipment— where higher concentration of leaked refrigerant is more likely.
- Indoor-installed dehumidifiers would also have additional damper installed at the compressor compartment (not shown on the drawings – typically, on the inner wall of compressor compartment) to ensure this compartment ventilation in event of the leak (see chapter “**Sequence of Operation**” for more details)

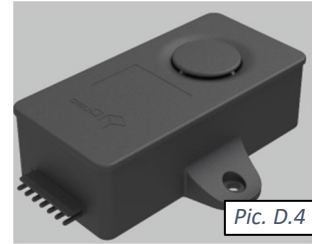

Main Electric Panel, apart from devices listed above (control board, OP, etc.) also contains **Voltage Monitor**; some optional control sensors and devices such as an air pressure differential sensor, current sensor(s). It may also be located in main electrical panel or in the dehumidifier in general.

Outdoor Air Fluid Coolers Layout and Components.

The general layout of AC options (air-and water-cooled) is shown on Pic.D.5 below with the outdoor fluid cooler *NG-V-12*, equipped with additional pump package (*Fig.1*) and *NG-V-32* (*Fig.2*) as an example. While layout and main components are similar for all applicable AC options, there are some deviations (number of fans, composition, etc.). Refer to **AC Options Basic View** (**Basic Information** chapter) for additional information.

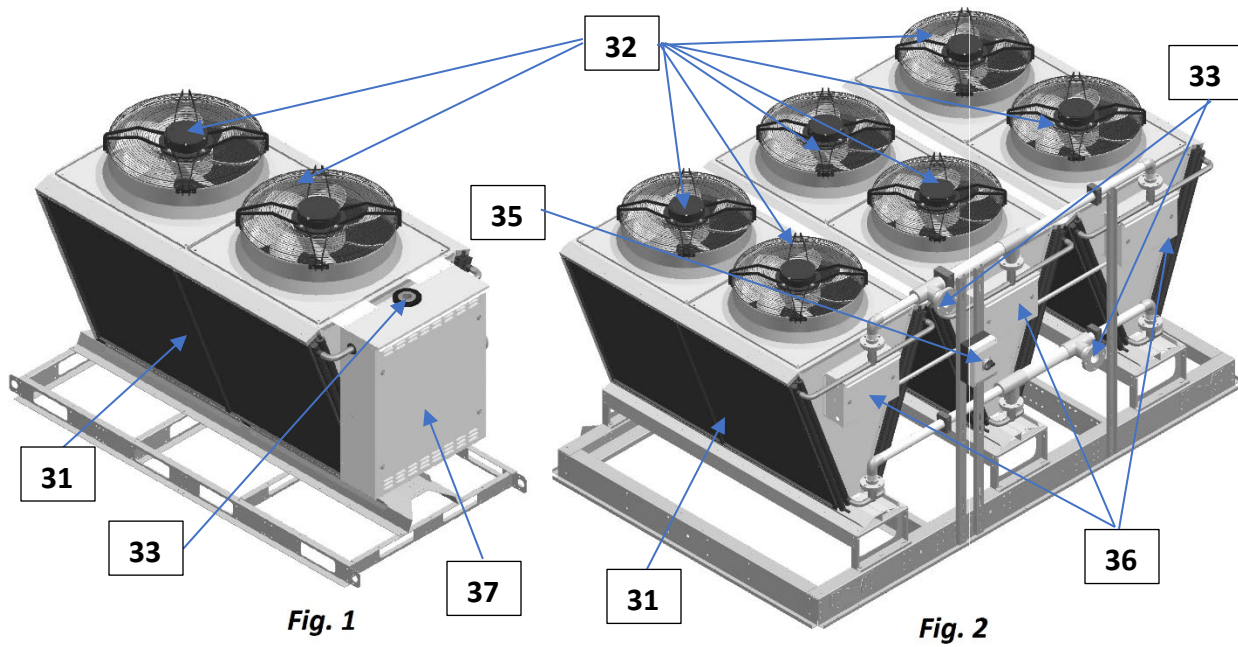

Pic. D.5

- Cooling (AC) **coils** (31) (where heat from glycol mixture is rejected to the ambient air) is mounted onto metal frame, upstream (before) the **fans** (32), that pulls the air through the coils to absorb the heat.
 - Normally, fluid cooler would have multiple coils and fans. Cooler NG-V-12 (Fig.1), comprised of two coils, mounted on the angle to each other, and two fans, presents a single block. Depending on the capacity, cooler could be comprised of up to six such single blocks, stacked side by side on the same frame and manifolded together – NG-V-32 is comprised of three such blocks.
- Cooler **pipng connections** (33) are identified respectively (IN – OUT);
 - In some cases, fluid cooler piping connection(s) may be located within **pump package** box (37), if fluid cooler is provided with one.
 - Piping connection location may vary – refer to particular cooler labels, stickers, submittal and other documentation.
- Electric power is normally to be brought to **disconnect** (35) (if cooler is equipped with such), which feeds it to the **electrical box** (36), that contains cooler power and control apparatuses.
 - Depending on fluid cooler specifics, location of electrical box may slightly differ; in some cases, electrical box may be incorporated into pump package or located on the opposite side of the fluid cooler.

Fluid Coolers Pump Package.

Fluid Coolers, if equipped with such option, would have a **pump package** box. Pic.D.6 below shows general layout of pump packages, used for NG-V model fluid coolers. Note, that the package could be mounted onto the fluid cooler directly (standard) or provided separately.

- **Pump** (38) establishes glycol mixture circulation through the fluid cooler and dehumidifier;
- **Expansion tank** (39) compensates for temperature-based glycol volume fluctuation;
- The pump package **electrical sub-panel** (40) contains the pump package electrical power and control apparatuses.
- The pump package manifolds are usually equipped with pressure gauges, automatic air venting valve, draining and other valves.

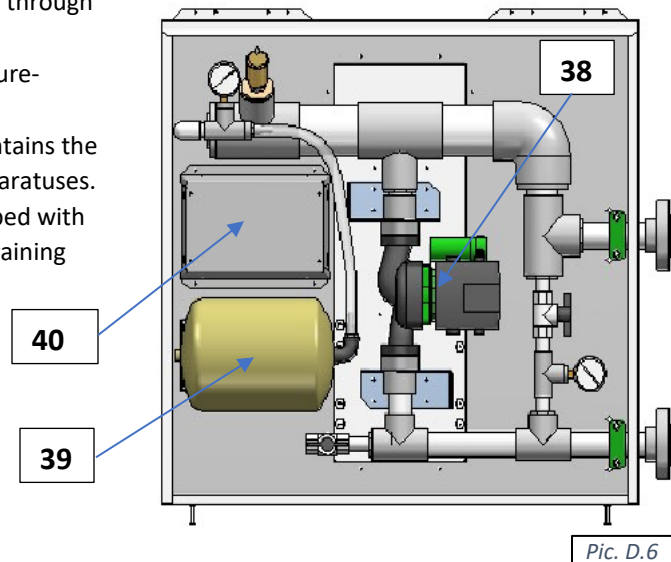

Sequence of Operation

The dehumidifier's ventilation system establishes the required airflow through the dehumidifier. The control system compares air temperature and humidity to their desired values (set points) and proceeds to dehumidify, cool or heat the recirculating air.

If the dehumidifier is equipped with the pool water heating option, the pool water temperature is compared to its set point and pool heating is provided if required.

Set Points

The control system is constantly adjusting unit operation to achieve and maintain said parameters within couple degrees/percent of the set point.

Refer to the dehumidifier's main label for the design value of control parameters, as well as the following note.

Note: To ensure the dehumidifier's most economical operation, we recommend maintaining the following relationship between pool water and room air temperatures:

$$\text{Room Air T} = \text{Pool Water T} + 2^{\circ}\text{F}$$

Ventilation.

The **main blower** runs continuously, establishing required. The main blower speed is pre-set via adjustable variable signal.

Minimum Exhaust Fan (EF), if dehumidifier is equipped with such option, directs portion of return air outdoors. Like main blower, exhaust fan(s) speed is also controlled via adjustable (pre-set) variable signal, that varies based on scheduled ventilation mode (Occupied, Non-Occupied and Spectator) or call for Economiser Mode (as part of Air Conditioning and/or Dehumidification operation).

Minimum Outdoor Air (OA) damper, if dehumidifier is equipped with such option, opens to introduce fresh outdoor air into the premise. OA damper could be equipped with ON/OFF (simple fully open – fully closed) or modulating-controlled actuator; latter one would be controlled same way as minimum exhaust fan.

Purge (Additional Exhaust) Option.

Along with **Min Exhaust Fan** and **Min Outdoor Air** damper, dehumidifier could have additional set of **exhaust (purge) fan(s)** (PF) and **purge outdoor air damper** (POA), commonly referred as **Purge**. Purge fan(s) and OA damper(s) function is to allow for higher exhaust and fresh air amount, up to complete (100%) air changeover (when all exhaust fans and OA dampers are at their max capacities).

Purge Fan(s) and **Purge Outdoor Air** damper(s) are controlled in the same fashion as **min exhaust fans** and **min outdoor air**. Some dehumidifiers may be equipped with additional **Return Air** damper: it closes in event of complete air changeover, separating return air side of dehumidifier from supply side (refer to **Layout and Components** chapter, as needed, for respective devices' location).

Complete air changeover, triggered manually, is known as **Purge Mode**.

- **Note.** Externally installed Exhaust Fan(s) and Outdoor Air damper(s) could be also controlled by the dehumidifier control system. This applies to both, **Minimum** and **Purge/Additional**, fans and dampers.

Heat Recovery Option.

Dehumidifiers, packaged with Minimum Exhaust Fan and Minimum Outdoor Air damper, could also have additional **Heat Recovery** (HR) closed-loop glycol system.

Heat Recovery loop (see Pic. E.1 below) consists of two coils (air-to-glycol heat exchangers) and a pump, establishing glycol circulation between them. One coil, installed at exhaust air opening, recovers portion of exhausted air energy, another coil, installed at outdoor air intake, transfers this captured energy to entering outdoor air.

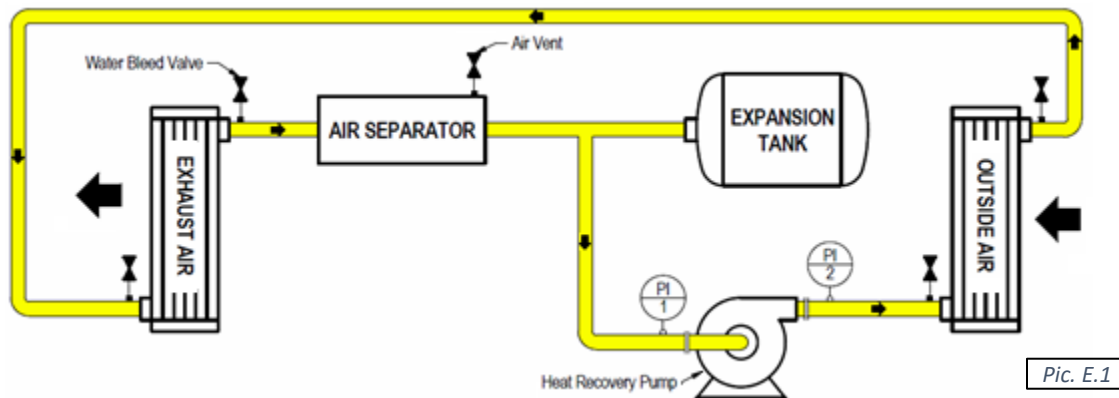

Pic. E.1

Space Heating

When premise air temperature drops below the set point, the dehumidifier control system issues a call for Space Heating Mode and engages space heater (electric heater, hot water coil with valve, gas boiler etc.) by sending space heating signal, respective to space heater control type - on/off, variable (0-10VDC), etc.

Air Conditioning, Dehumidification and Pool Heating.

When premise air temperature goes over (exceeds) its set point, the dehumidifier control system issues a call for Air Conditioning Mode. Respectively, when premise air humidity goes over (exceeds) its set point, the dehumidifier control system issues a call for Dehumidification Mode. In some instances, these calls may co-exist.

To execute Dehumidification or Air Conditioning (Cooling) mode, control system, depending on current conditions, would resort to available means of cooling or dehumidification.

Economiser Mode Option.

- **Note.** *Economiser Mode requires dehumidifier to be equipped with full (min and additional) exhaust and outdoor air options!*

If outdoor air is dry and/or cool, it could be used to dehumidify and/or cool the premise. In this case, on call for Dehumidification or Air Conditioning mode(s), control system would simply increase exhaust fan(s) speed signal to direct more stale return air outside and bring in more outdoor (dry/cool) air in, thus reducing supply air humidity and/or temperature (as needed).

Compressor(s)

Whenever the compressor operates, the evaporator is always dehumidifying and cooling the return air. The heat removed from the air at the evaporator, as well as the heat from the compressor's action, must be rejected to one of three heat sinks: room (premise) air, pool water (if applicable) or outdoors. The control system will direct the heat to where it is needed based on room (air and pool water temperature) conditions:

- If room air is needed to be warmed up – more heat is diverted towards reheat coil;
- If pool water is needed to be warmed up – more heat is diverted towards pool water heat exchanger (if dehumidifier is equipped with this option).
- Rest of the heat (if any) is diverted towards outdoors (outdoor fluid cooler, external heat sinks etc.)

Compressor Circuit Operation

Piping schematic for compressor circuit is shown on Pic. E.2.

- Schematic shows single compressor circuit (second compressor circuit schematic is the same) and common to both compressor circuits' glycol cooling circuit.
- Circuit operation below applies to both compressors; compressors are staged – if first compressor's capacity is not enough to satisfy the call, second (sequential) compressor(s) will be engaged after certain time delay.

When a demand requires the compressor to operate, the following sequence occurs:

- Once blower operation, related safeties and timers are confirmed by the control system, following occurs:
 - Compressor glycol pump starts, establishing cooling glycol/water flow through the compressor fluid circuit - plate heat exchanger(s) and fluid cooling coils (reheat and/or fluid cooler or external cooling source).
 - Pump down solenoid valve opens and once pressure stabilizes, the compressor starts.
- Based on the premise air temperature, the Reheat (RHV) and Reheat Bypass (RBV) valves would adjust their opening position (open more/close more), reducing or increasing fluid flow to the respective fluid coils:
 - if more heat is required by the room air, RHV valve opens more, and RBV valve closes more, thus diverting more fluid to the reheat coils (heat is rejected to the premise); if room requires less heat – opposite sequence occurs (RHV valve closes more, and RBV opens more).
 - RHV and RBV valves are controlled in the same manner with opposite effect: for example, when RHV valve opens 10% more, RBV valve closes 10% more etc.
- If dehumidifier is equipped with pool water heating option (glycol-to-pool water heat exchanger), then, based on pool water temperature, Pool heating (PHV) and Air Conditioning/Cooling (ACV) valves would adjust their opening position (open more/close more, similar to RHV and RBV):
 - if more heating is required by the pool water, the PHV valve opens more, and ACV valve closes more, thus diverting more fluid to pool heating heat exchanger.
- Remainder of the fluid (diverted from reheat coil and pool heat exchanger), if any, is sent to the outdoors (Fluid Cooler or other external heat sink).
 - Outdoor fluid cooler fans are engaged only if at least some fluid is diverted towards outdoor fluid cooler and compressor pressure is higher than pre-set level (see **Outdoor Fluid Cooler Operation** below).
- Once demand for the compressor's operation is removed (respective call is satisfied), the pump down solenoid valve closes; once the compressor suction pressure reaches the pre-set pressure, the glycol pump and compressor stop.

Outdoor Fluid Cooler Operation.

Based on the type of the outdoor condenser or fluid cooler fans' type (two-speed fans or EC-type/modulating fans), respective signal(s) are sent by control system to engage said fan(s): for two-speed fans - on/off signals (switching speeds, based on compressor head pressure level), for EC-type fans - variable 0-10VDC signal (proportional to the compressor head pressure level). Refer to the fans' type and wiring diagram if/when needed.

If the fluid cooler is equipped with the built-in pump package (to establish cooling fluid flow between dehumidifier and the fluid cooler or to serve as additional/booster pump), the said pump is also engaged along with fluid cooler fans – pump would stay engaged while fans are engaged (regardless of the fans’ speed).

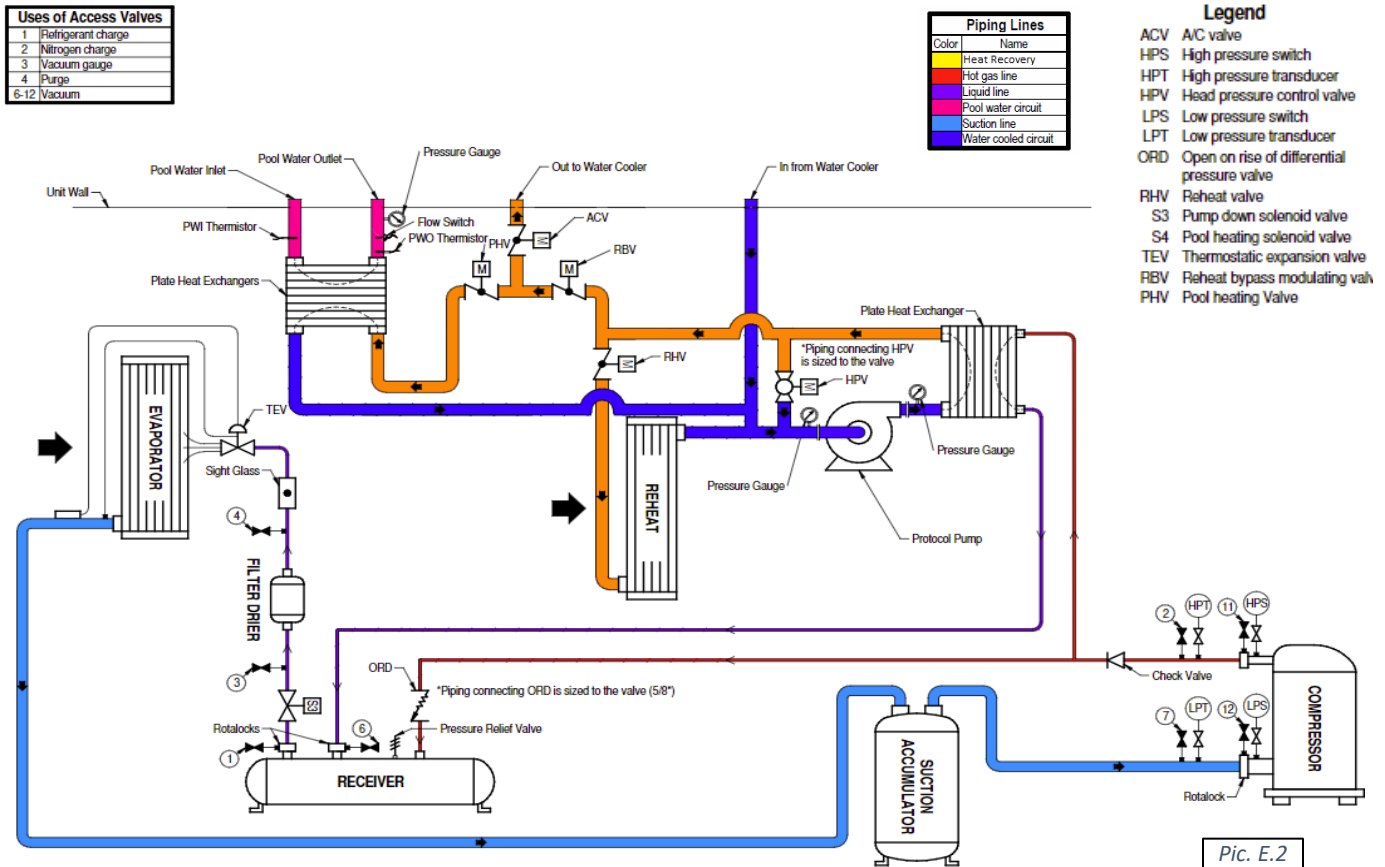

A2L Refrigerant Mitigation Control

Dehumidifiers, that contain A2L (mildly flammable) refrigerant (like R454B), employ additional mechanisms (devices and control algorithm) to ensure the safety if refrigerant leak occurs.

Initial Ventilation Design and Emergency Venting

Danger of explosion of A2L refrigerant would occur if its concentration in the air would be above certain level. Apart RDS detecting presence of refrigerant at much lower concentration, another safety mechanism is embedded at the design and selection of the dehumidifier for respective premise:

- Dehumidifier’s min blower(s) capacity is selected in such a way that they will create enough of the airflow to vent all the air (with leaked in refrigerant) into conditioned space at concentration much lower than the dangerous one.
- The dehumidifier refrigerant charge and size (area, volume etc.) of conditioned space are matched in such a way that conditioned space would allow for dilution of leaked refrigerant to the point (concentration) that does not present danger.

- To ensure that all dehumidifier's compartments are properly vented (in event of a leak), indoor-installed dehumidifiers are equipped with Emergency Venting:
 - compressor compartment (typically the only compartment that is outside of main airstream and thus not ventilated) is equipped with emergency damper, that will open (triggered by RDS in event of a leak) to allow for compressor compartment to be properly vented as well.
 - Outdoor- installed dehumidifiers would not be equipped with such option, since refrigerant leaking outside, would be diluted into atmosphere without presenting a danger of explosion.

Refrigerant Detection System (RDS).

Each dehumidifier is equipped with RDS – set of refrigerant sensors, installed within the dehumidifier, that detect presence of refrigerant in the air at very low concentration (that does not have a potential for ignition or explosion).

If RDS detects presence of the refrigerant within dehumidifier compartments, it triggers series of mitigating actions:

- ✓ Switches main blower operation to maintain airflow equal or above **Q_{minTA}** (see **Table 2** prior); typically, airflow is higher than that by technological requirements (min air exchanges), but RDS will ensure this anyway.
- ✓ For indoor-installed dehumidifiers, RDS will trigger compressor compartment Emergency Venting (see details above)
- ✓ Compressor operation is stopped.

Interface and Communication

Touch Display Operator Panel

The Touch Display Operator Panel (OP), shown on Pic. F.1, is used as a main interface between the dehumidifier and operator. The same OP can be located in the dehumidifier main electric panel (default; used as a local OP) or installed remotely from the dehumidifier

- **NOTE:** length of CAT5 or CAT6 cable, between remote OP and the dehumidifier MUST NOT exceed 1000'!

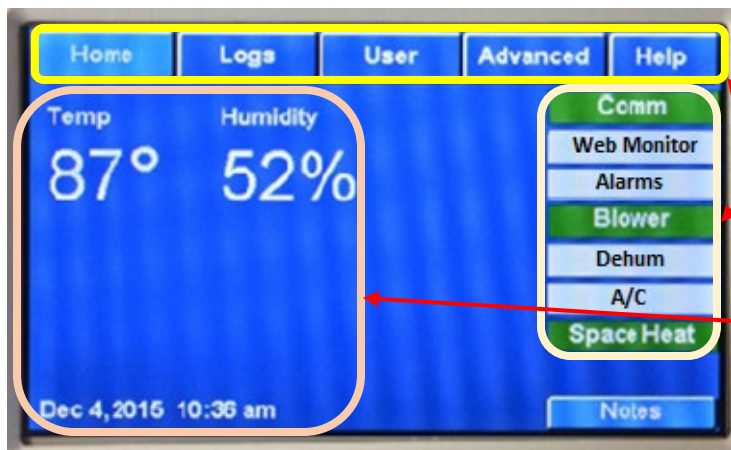

Pic. F.1

Touch Display OP allows to:

Access Touch Display **Menus**

View dehumidifier current operational statuses (Touch Display Communication, Alarms, dehumidifier operational calls, etc.)

View controlled parameters' values (premise air temperature, humidity and, if applicable, pool water temperature) and current date and time.

Touch Display Menus:

Home	Opens/returns to the home page
Logs	Access to dehumidifier logs and log-related features (Alarms , etc.)
User	Access to user settings (Setpoints) and commands (Stop/Restart Dehumidifier, etc.)
Advanced	Access to advanced settings and features
Help	Context sensitive help presenting information related to the viewed page

Most common/basic maintenance tasks performed using Touch Display OP

- ✓ **Adjust Setpoint** – in **User** menu: press the **User** button, then press the **Setpoints** button; select desired parameter (room air temperature etc.) and enter the desired value. Press the **Enter** button to confirm the entered value.
- ✓ **Stop/Restart Dehumidifier** — in **User** menu: press the **User** button, then press the **System Restart** button;
 - To stop and restart dehumidifier, press the **System Restart** button
 - To reboot Touch Display OP, press the **Restart Display** button
- ✓ **Review Alarm records** — done via the **Logs** menu: press the **Logs** button, then press the **Alarm Log** button.
- ✓ **Unlock device/dehumidifier, stopped and currently locked out on the alarm** — done via **Logs** menu: press the **Logs** button, then press the **Current Alarms** button; press the **Clear** button next to the respective alarm (the alarm that's locked out the device or entire dehumidifier).

For detailed information on TouchDisplay OP refer to **DASV Touch Display Manual**, provided with the dehumidifier (or contact factory to obtain a copy).

Alarms

If the dehumidifier control system detects abnormal or unsafe for further operation situation, it issues **Alarm** (notification of such situation accompanied by respective component or entire dehumidifier stoppage and/or lockout) or **Alert** (notification of minor abnormal situation without any devices' stoppage or lockout).

All alarms and alerts are recorded and can be viewed/cleared via the Touch Display OP:

- ✓ Viewed: to facilitate troubleshooting and addressing abnormal situation
- ✓ Cleared: to unlock stopped device or entire dehumidifier and allow for further operation

The table F.1 below lists the basic alarms with their descriptions and recommended initial troubleshooting.

Alarm	Alarm Description	Check
No Air	No air flow (air flow switch fault – <i>if air flow switch is installed</i>)	Check main blower operation and air flow switch
Blower OL	Main Blower overload/safety fault	Check main blower operation and its LED light blinking pattern.
Fire	Fire/smoke detector fault – <i>if detector is installed externally and connected to control board</i>	Check external fire/smoke detector/system
Freeze	Supply Air temperature is lower than Freezestat Setting (default: 45 F)	Check SA temperature readout, space heating system operation
Filter	<u>Alert</u> , indicating that filter change timer has lapsed – <i>if timer is activated</i>	Clear the Filter alarm and cancel filter scheduler if not in use.
VM	Voltage Monitor fault – power supply (phasing, voltage etc.) is outside of pre-set limits	Check Voltage Monitor info/status, incoming power (voltage)
Compressor: - HP1-(X) - LP1-(X) - SupHeat1 - DisTemp1	Various compressor-related alarms, relevant to: - Compressor high/discharge pressure; - Compressor low/suction pressure; - Compressor superheat/suction temperature;	Check respective compressor-related data (pressure and temperature readouts), refrigerant level in the receiver's sight glasses, cleanliness of air-side coils and air filters.
Pool Water: Water(X)1, Wtr(X)1	Various compressor pool water heating-related alarms indicating inadequate (too low/too high) pool water flow and/or pool water temperature.	Unless the alarm occurred due to a known water flow interruption (backwash, etc.), check the pool water flow (pump, filters, valves) and pool water temperatures.
HPRelief	<u>Alert</u> , indicating that additional condensing capacity is engaged (pool water heat exchanger etc.) to prevent compressor high pressure from rising too high.	No action required unless it's accompanied by other (compressor-related) alarm or faulty situation.

- ✓ Note that proper and regular maintenance (example: keeping air filters and air-side coils clean) should reduce the chances of abnormal operations, dehumidifier alarm-related stoppages and downtime.

CAUTION! We recommend you have a qualified professional investigate and remedy all reoccurring alarm-related stoppages and lock-outs. Continuous dehumidifier restarting (clearing alarms) without addressing actual issues may result in equipment malfunction, premature wear, and failure.

For more details regarding alarms and alerts, refer to the **Alarms Description** information (available via Help feature in Touch Display OP); contact factory if needed.

Remote Communication

Although dehumidifier is designed to operate as a self-controlled device (not requiring any external control), communication between the dehumidifier and external control and monitoring systems is possible.

WebSentry

WebSentry is an online tool (also referred to as Web Monitor), that allows for remote communication to the dehumidifier for various purposes such as monitoring, data collection, parameters adjustment, and notifications. This feature is included with all dehumidifiers and is useful for maintenance teams and service providers (HVACR technicians).

To establish Web Monitor communication, the dehumidifier must communicate with the factory server via the Internet:

- Connect the dehumidifier to a local network switch, router or wireless AP device (providing connection to a local network):
 - o Plug an Ethernet cable into the sub-board Ethernet RJ-45 jack (sub-board, called Core Module, is located on the main control board in the main electric panel) – see Pic. F.2.
 - **Note:** separate RJ-45 jack (plastic, black) is mounted on the control board directly, for TouchDisplay connection. Make sure to use the proper jack (metal-surface one, located on the sub-board) for Web Monitor connection.
- Configure, as needed, local server and dehumidifier network settings.

BMS (Building Management System)

Communication to BMS can also be supported, depending on the type of communication protocol said BMS utilizes.

The equipment control software supports most common of them

- different control software variation might be required to support different BMS communication protocols. Contact factory if necessary.

BACnet (Internet, IP). Communication is established via the Ethernet cable (same method as Web Monitor).

- ✓ BACnet and Web Monitor communication can be used simultaneously.

LON or Modbus. Communication requires external wiring between dehumidifier main control board and BMS terminal. Wiring schematic is normally indicated on wiring diagram (provided with dehumidifier).

- ✓ If dehumidifier is equipped with LON communication option, it's normally provided with pre-wired LonWorks Gateway for communication purposes.

For more information about Web Monitor or BMS communication set up (connection, configuration, access, point cutsheets, etc.) – contact factory.

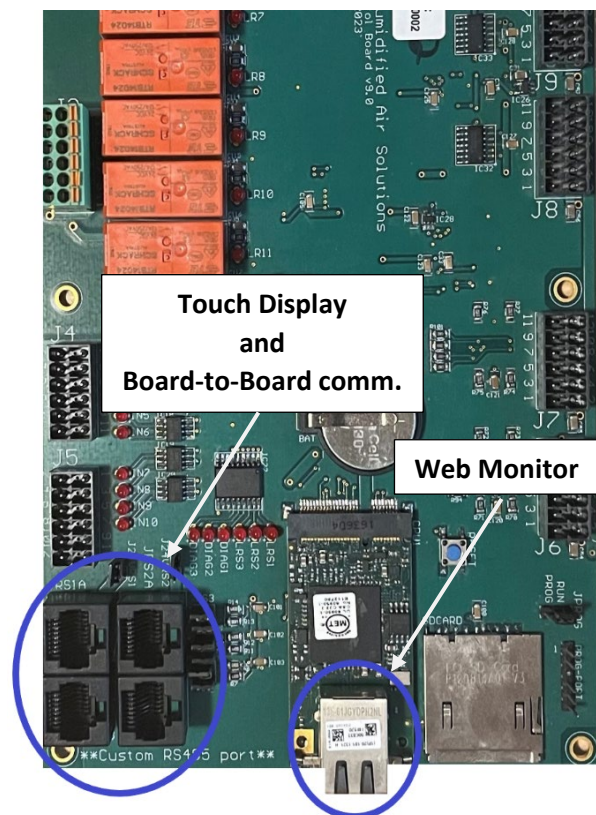

Pic. F.2

General Considerations for any Work, Performed on the Equipment

Whether performing routine, day-to-day maintenance or one-off (commissioning, repair etc.) work tasks, one must recognize potential hazards, associated with the task to be performed, equipment and its installation specifics, as well as be properly trained and qualified to perform such tasks (for training and qualification requirements – refer to chapter “**Personnel Training and Qualification**”).

 **WARNING!** Any work (installation, start up, service, maintenance, repair, etc.) on the equipment must be performed by respectively trained and qualified individuals!
Refer to the requirements, outlined in chapter “**Personnel Training and Qualification**”!

 **WARNING!** Dehumidifier, equipped with compressor(s) contain A2L (mildly flammable) refrigerant!

NOTE! Info in this sub-chapter is applicable to **ALL individuals**, performing **ALL tasks: maintenance, service, repair, commissioning/start-up and decommissioning**.

Potential Hazards Associated with Equipment

- **Moving mechanical parts**, components under high pressures and surfaces with high temperatures. Before entering the dehumidifier and/or performing any equipment maintenance work, make sure that all moving parts are stopped, surfaces are cool, and it is safe to perform required task.
- **Electrical power**. Before performing any maintenance, disconnect all electrical power, including remote disconnect, and discharge all energy storing devices (VFDs, etc.) before servicing. Follow proper lockout procedures to ensure that power cannot be accidentally restored. Failure to follow provided safety warnings and labels could result in serious injury or death.
- **A2L refrigerant**. Dehumidifiers, equipped with compressor(s), contain A2L (**mildly flammable**) refrigerant.
 - Beware of possibility of leak and refrigerant concentration with potential to cause explosion/fire:
 - Ensure there is no open flames or other potential ignition sources!
 - Ensure there is sufficient ventilation!
 - Dehumidifier is equipped with safety mechanisms to mitigate the potential effects of the refrigerant leak; these mechanisms (ventilation, RDS etc.) rely on the equipment being powered, and respectively, these mechanisms are not active when equipment is powered down – beware of it!

Considerations Associated with Equipment Installation, Location or Connection

- Location, placement:
 - Equipment, containing A2L refrigerant, must comply with requirements, shown in **Table 1 and 2** (see chapter “**Special Considerations for Equipment Containing A2L Refrigerant**”)!
 - Equipment, both indoors and outdoors, must NOT be accessible to general public;
 - Equipment, installed on the elevated surfaces (roof etc.) must have means, as applicable, to prevent personnel (maintenance, service, repair etc.) working on/with equipment, from falling – refer to respective Codes and Regulations.
 - Mechanical room, where dehumidifier is installed, and dehumidifier installation must comply with requirement **CSA B52/ASHRAE 15** for **MACHINERY ROOMS**. Requirements include, but not limited to, following (refer to respective Code):

- Machinery room shall be of a tight construction and not accessible to general public.
- Machinery room with equipment that contains A2L refrigerant shall:
 - be mechanically vented outdoors
 - be equipped with refrigerant detection system
 - have NO flame-producing devices or hot surfaces permanently installed in the room
- Parts and components – general:
 - Sealed electrical components shall be replaced instead of repaired.
 - Intrinsically safe components shall be replaced instead of repaired.
- Ductwork:
 - Ductwork connections (between duct in the conditioned space and the dehumidifier) must be of tight construction. Ducts passing through a machinery room shall be of tight construction and shall have no openings
 - Dehumidifier with compressor(s) contains A2L refrigerant and relies on full ventilation via ductwork as means to mitigate potential leak and accumulation of refrigerant beyond dangerous concentration - any auxiliary devices that have a potential to become an ignition source are NOT permitted to be installed within ductwork.
- Piping:
 - Refrigeration piping (material, routing, installation), connecting dehumidifier and outdoor condenser shall comply with national and local Codes and Regulations, such as **CSA B52/ASHRAE 15** (and other as applicable) as well as proper field practises applicable to respective work tasks (piping, brazing, pressure/leak test, evacuation, charging, recovery etc.).
 - Piping shall be protected from physical damage in operation and service.
- Power:
 - Ensure that cabling/wiring are not subject to wear, corrosion, excessive pressure, vibration, sharp edges or any other adverse environmental effects. Account for the effects of aging or continual vibration (from equipment components, such as compressor, fan etc.)

Refer to respective chapter below, related to specific work task(s) (maintenance, service, repair etc.) for details, as well as to respective Codes and Regulations and best field practices.

Basic Maintenance

Although Seresco equipment is built for minimal service downtime, periodic preventative maintenance is required to ensure maximum reliability, safety, and operating efficiency.

 **WARNING!** To ensure equipment longevity and proper and efficient operation, the dehumidifier and its auxiliary systems and devices (outdoor condenser, fluid cooler, boiler package, etc.) **must be maintained** properly and regularly. It is recommended to create a **facility-specific Routine Maintenance Program**. Failure to maintain the equipment properly and regularly could result in personal injury, equipment damage or malfunction and will void the equipment warranty.

 **WARNING!** Review and follow details in chapter “**Work Tasks and Safety – General Considerations**” in addition to current chapter to ensure safety of performed tasks!

Maintenance Training and Tools

The only tasks performed should be the ones individual is qualified and trained for:

- When it is necessary to work with live electrical components, have a licensed electrician or other qualified professional perform the required task.
- Some maintenance tasks may involve usage of power tools, chemicals, etc. Refer to such tools and materials data (manuals, MSDS, etc.). Personnel performing such maintenance tasks should be:
 - Properly trained to handle such tools and materials safely
 - Equipped with proper personal protective equipment

Maintenance Key Points

Here are some basic/key maintenance considerations, pertinent to all dehumidifiers and their auxiliary systems:

- Dehumidifier in mechanical room. **No chemicals** should be stored **in the same mechanical room** where the dehumidifier is installed. Chemical fumes/off-gas can cause premature deterioration of the equipment.
 - Store chemicals in a separate, well-ventilated room.
- Access to the Equipment. Ensure that the **equipment is accessible** (minimum clearances are maintained): approaches to the dehumidifier are not restricted/limited with materials in mechanical room (indoor installed) or with snow (outdoor installed dehumidifiers, OACC and O AFC).
- “MUST DO” maintenance task. Although all other maintenance tasks are as important, these two maintenance tasks are the most common and most helpful:
 - Maintain **clean air filters** (return, outdoor air filters, etc.). Make sure to replace dirty filters regularly.
 - Maintain **clean air-side coils** (especially Outdoor Condenser or Fluid Cooler). Make sure to clean coils regularly.
- Pool Water Chemistry. Incorrect pool water chemistry (improper pH level or high concentration of chlorine, sea salt or other corrosive additives etc.) can result in equipment premature wear or malfunction (let alone poor air quality in the pool and potential health issues) and will void the equipment warranty. Refer to pool water quality standards; contact factory as needed.

Routine Maintenance Program

Creating facility-specific routine maintenance program and following it is vital to equipment longevity and efficient operation.

The suggested general maintenance operations and their frequency/intervals, listed in the table M-1 below, can be used to create such a program. For more detailed maintenance recommendations related to specific components, refer to the respective component manufacturer’s manual.

Table M.1. Recommended Maintenance Tasks and Intervals	
Interval	Maintenance Task
Weekly	Observe the equipment for any changes in running conditions and unusual noise
Quarterly	Clean or replace air filters if clogged or dirty
	Verify that all set-points are correctly programmed as specified by the facility operator
Semi-Annually	Inspect and clean the drain pan(s)
	Tighten electrical connections, if required
	Check and tighten, if required, pool water hose clamps and sensor mounts
	Inspect all airside coils (outdoor condenser, fluid cooler, dehumidifier coils – evaporator, etc.) for dirt, cobweb build-up, etc.; clean as needed
	Check that the P-trap is primed (filled with water). It is good practice to pour some water into the drain pan to ensure that the P-trap is primed and operational
	Check the outdoor air louvres and dampers for accumulation of dust and clean as required
	Inspect the equipment’s cabinet for corrosion. If any damage is found, clean and repaint the affected surface with a rust-resistant primer
Annually	Clean the fan wheel(s)
	Check dampers operation (linkage/actuator is not loose, damper opens/closes properly etc.)
	Inspect electrical components, wiring and insulation
	Rotate the fan wheel(s) and check for obstructions and rubbing
	Check gasket condition on all doors to ensure an airtight seal
	Check bolts on compressors, motor mounts, dehumidifier bases and coils and tighten if required
	Verify that the airflow around the remote condenser or dry cooler is unobstructed

Specific Components Maintenance

Actual maintenance plan may vary from installation to installation, yet there are several key components from maintenance prospective.

If needed, contact respective component manufacturer for additional maintenance information.

RDS Sensor (Equipment with A2L refrigerant)

Refrigerant sensor, installed within the dehumidifier, does not require any specific maintenance.

Used sensor has long-life expectancy and not required to be replaced on regular basis.

Failed sensor should be replaced with the same type/brand; consult equipment manufacturer before replacing sensor with different type/brand.

Filters

- Ensure air filters are clean. Dirty air filters will negatively affect dehumidifier performance and lifetime
- Frequency of filters replacement will vary based on air quality, dehumidifier usage, facility type, etc. Make sure to replace filters regularly
- Replace with filters of equivalent size and rating – refer to dehumidifier details (compartment stickers, etc.)

Insulation

Inspect dehumidifier insulation, exposed to airstream for microbial growth (i.e., mold). If there is evidence of microbial growth on the interior insulation, the insulation should be removed and replaced prior to operating the dehumidifier.

Air-Side Coils

- **Warning: Hazardous chemicals!** Cleaning agents can be highly acidic or alkaline. Handle all chemicals carefully and use appropriate personal protective equipment (PPE). Refer to the cleaning agent manufacturer's Materials Safety Data Sheet (MSDS) for safety and handling information. Failure to follow all safety instructions could result in serious injury or death.
- **Warning: Hazardous pressures!** Coils containing refrigerant under pressure must not be cleaned using a solution over 150 °F. Failure to follow these safety precautions could result in coil bursting, which could result in serious injury or death.

To clean the coil

- Disconnect all electrical power to the equipment
- Use a soft brush to remove loose debris from the coil
- Mix a high-quality coil cleaning detergent with water according to the manufacturer's instructions
- Clean coil according to suggested instructions
- Thoroughly rinse both sides of the coil and the drain pan with, clean water
- Straighten any coil fins that have been bent during the cleaning process
- Confirm the drain line is clear
- Replace all panels and parts and restore electrical power to the equipment

Special Maintenance Tasks. Fluid Cooler Winterization.

Normally fluid coolers are used in the systems, filled with glycol mixture to prevent the system and the fluid cooler from freezing and, potentially, rupturing, when exposed to temperatures below freezing point.

When fluid cooler is used with media that, when exposed to low temperatures, could freeze (water or lower-percentage glycol mixture), one way to protect the equipment is to drain it (also known as “winterization” of the equipment).

Though fluid cooler itself is normally equipped with means to be drained properly/fully, it is recommended to have same means in place for entire system (fluid cooler – piping – dehumidifier etc.):

- Have each local high point of the system equipped with means to bleed the air (air bleeding valve etc.)
- Have each local low point of the system equipped with means to drain the fluid.

 **CAUTION.** Draining and re-filling the fluid cooler must be performed by trained personnel, according to proper field practice and system layout. Improper draining or re-filling the system could lead to equipment damage, malfunction, premature tear and ware and may void equipment warranty.

 **CAUTION.** Ensuring that the fluid cooler and associated system(s) equipped with proper means of draining, creating draining and re-filling procedures as well as determining whether draining is warranted to protect the equipment is outside of manufacturer’s scope and is a responsibility of installing contractor and local maintenance team.

Service, Repair, Commissioning and Decommissioning

 **WARNING!** Review and follow details in chapter “**Work Tasks and Safety – General Considerations**” in addition to current chapter to ensure safety of performed tasks!

In some instances, more intrusive/specific work tasks (apart from routine maintenance) required. Apart from standard best field practices and Codes and regulations, applicable to respective tasks, it is critical to consider some equipment and its installation-specific details.

 **WARNING!** Any work (service, repair, decommissioning etc.) on the equipment must be performed by respectively trained and qualified individuals!

 **WARNING!** Dehumidifier, equipped with compressor(s) contain A2L (mildly flammable) refrigerant!

It is essential for any personnel carrying out any work on this equipment to be familiar with the equipment, its operation and details.

General Considerations and Checks

Work shall be undertaken under a controlled procedure so as to minimise the risk of a flammable gas or vapour being present while the work is being performed.

- **General Area Check (where equipment is installed and/or work to be performed):**
- Prior to beginning work on systems, perform safety checks to ensure that the risk of ignition is minimised.
 - All maintenance staff and others working in the local area shall be instructed on the nature of work being carried out.
 - Work in confined spaces shall be avoided.
 - *Fire extinguishing equipment.* If any hot work is to be conducted on the refrigerating equipment or any associated parts, appropriate fire extinguishing equipment shall be available (like a dry powder or CO₂ fire extinguisher).
- **Ventilation Check.** Ensure that the area is in the open or that it is adequately ventilated before breaking into the refrigeration system or conducting any hot work (brazing etc.). A degree of ventilation shall continue during the period that the work is carried out. The ventilation should safely disperse released refrigerant (if any) and preferably expel it externally into the atmosphere.
- **Presence of Refrigerant in Atmosphere Check.** The area shall be checked with an appropriate refrigerant detector prior to and during work, to be aware of potentially toxic or flammable atmospheres. Ensure that the leak detection equipment being used is suitable for use with all applicable refrigerants, i. e. non-sparking, adequately sealed or intrinsically safe. Refer to sub-chapter “Pressure/Leak Test. Leak Detection” below
- **Ignition Sources Check**
 - No person carrying out work in relation to a REFRIGERATING SYSTEM which involves exposing any pipe work shall use any sources of ignition in such a manner that it may lead to the risk of fire or explosion.
 - All possible ignition sources, including cigarette smoking, should be kept sufficiently far away from the work site, where/when refrigerant can possibly be released to the surrounding space.
 - Prior to work taking place, the area around the equipment is to be surveyed to make sure that there are no flammable hazards or ignition risks. “No Smoking” signs shall be displayed.
- **Electrical Devices Check.**
 - Repair and maintenance to electrical components shall include initial safety checks and component inspection procedures. Initial safety checks shall include:

- that capacitors are discharged: this shall be done in a safe manner to avoid possibility of sparking;
- that no live electrical components and wiring are exposed while charging, recovering or purging the system.
- that there is continuity of earth bonding
- If a fault exists that could compromise safety, then no electrical supply shall be connected to the circuit until it is satisfactorily dealt with.
 - If the fault cannot be corrected immediately but it is necessary to continue operation, an adequate temporary solution shall be used. This shall be reported to the owner of the equipment, so all parties are advised.
- Where electrical components are being changed, they shall be fit for the purpose and to the correct specification. At all times the manufacturer's maintenance and service guidelines shall be followed. If in doubt, consult the manufacturer's technical department for assistance.
- **Refrigerating Equipment and Piping Check**
 - The following checks shall be applied to installations using FLAMMABLE REFRIGERANTS:
 - the actual REFRIGERANT CHARGE is in accordance with the conditioned space and room size within which the refrigerant containing parts are installed (see table1 and 2)
 - the ventilation machinery and outlets are operating adequately and are not obstructed;
 - marking to the equipment continues to be visible and legible. Markings and signs that are illegible shall be corrected;
 - refrigerating pipe or components are installed in a position where they are unlikely to be exposed to any substance which may corrode refrigerant containing components, unless the components are constructed of materials which are inherently resistant to being corroded or are suitably protected against being so corroded.
 - All field refrigerant joints shall be accessible for inspection prior to being covered or enclosed

Refrigeration Work Tasks

When/if required, service or repair work on refrigeration piping and equipment, that contain A2L (mildly flammable) refrigerant must be conducted in safe manner, following specific recommendations of respective Codes and Regulations as well as best field/trade practices.

Pressure/Leak Testing. Leak Detection.

Refrigeration piping circuit must be leak-free to ensure problem-free operation of the equipment, comply with environmental and safety requirements. Following tasks to ensure that must be performed at different stages of piping.

After completion of respective work (repair, replacement etc.), the pipework shall be **PRESSURE TESTED** with an inert gas and then vacuum tested prior to refrigerant charging.

- Pressure-test circuit/equipment – refer to the dehumidifier main label for operating pressure level.
 - The minimum test pressure for the low side of the system shall be the low side design pressure and the minimum test pressure for the high side of the system shall be the high side design pressure, unless the high side of the system, cannot be isolated from the low side of the system in which case the entire system shall be pressure tested to the low side design pressure.
 - Use only dry nitrogen for pressure testing!
 - Ensure that dehumidifier valves are in proper position (open/closed – as required by particular task) to allow for proper propagation of test gas and/or isolate proper segment, if any, of the equipment/piping.

Once circuit successfully charged (after performing all needed steps, like brazing, vacuuming and charging – see below), all field refrigerant joints indoors shall be **TIGHTNESS/LEAK TESTED**.

- Test must be performed with device/method with sensitivity of 5 grams per year of refrigerant or better under a pressure of at least 0,25 times the maximum allowable pressure. No leak shall be detected.

A2L Refrigerant Leak Detection Methods.

⚠ WARNING! It is prohibited to use potential sources of ignition to search for refrigerant or for detection of refrigerant leaks! A halide torch (or any other detector using a naked flame) shall not be

Acceptable (for A2L refrigerant) leak detection methods include:

- “Bubble” method (special leak-detection soap could be used, that forms bubble at the leak point). It is not recommended to use chlorine-containing liquids for this purpose.
- Electronic Leak Detection (by using ELD – Electronic leak Detector). Ensure the following:
 - ELD is not a potential source of ignition and is suitable for refrigerant used – refer to ELD manufacturer data
 - ELD is properly and regularly calibrated:
 - Calibration must be done in refrigerant-free area
 - Leak detection equipment shall be set at a percentage of the *LFL* of the refrigerant and shall be calibrated to the refrigerant employed, and the appropriate percentage of gas (25 % maximum) is confirmed.

Evacuation and Charging

Perform evacuation (vacuuming) before charging system/its portion with the refrigerant:

- Verify/check evacuation and charging tools (vacuum pump, hoses etc.) for following:
 - compatibility with refrigerant used in the system
 - not being used with other refrigerants/oils to prevent cross-contamination
 - all tools in good order; hoses are not overly long (to minimize amount of refrigerant in them)
- Evacuate the system – ensure that vacuum of **250 microns** (min) is achieved and held for **30 min**. Follow best field/trade practice.
 - Ensure that the outlet for the vacuum pump is not close to any potential ignition sources and that ventilation is available.
 - Ensure that evacuation devices and tools (vacuum pump, hoses etc.) are compatible.
- Charge the system with proper amount of proper refrigerant.
 - Refer to dehumidifier main label for **refrigerant type** and **charge** data. Ensure proper amount is added.
 - Charge with liquid refrigerant **ONLY!**
 - Ensure that charging cylinder(s) kept in an appropriate position.
 - Ensure that the REFRIGERATING SYSTEM is earthed prior to charging the system with refrigerant. Label the system when charging is complete (if not already)

A2L Refrigerant Recovery and Removal

In some cases (to make a repair of for any other purposes) refrigerant removal (recovery) is required. If system must be emptied of the refrigerant, refrigerant should not be vented to atmosphere, but properly removed! Conventional best recovery procedures and practices should be used with consideration of the flammability of the refrigerant.

- Before attempting the procedure, ensure that:
 - system is isolated electrically;
 - area is well ventilated
 - mechanical handling equipment is available, if required, for handling refrigerant cylinders;
 - all personal protective equipment is available and being used correctly;
 - the recovery process is supervised at all times by a competent person;
 - recovery equipment and cylinders conform to the appropriate standards. Verify following as well:
 - compatibility with refrigerant used in the system

- hoses, recovery machine, cylinders were not being used with other refrigerants/oils to prevent cross-contamination
- all tools in good order - cylinders are equipped with shut-off and pressure relief valve in good order, hoses with leak-free disconnects etc.
- proper/correct number and type of cylinders available - of sufficient type for recovery and sufficient size/capacity to contain all recovered refrigerant
- **NOTE:** *if refrigerant and/or oil is suspected to be faulty/not-acceptable (acidic etc.) or if recovery is done for decommissioning purposes, an oil and refrigerant sample shall be taken prior to the task being carried out in case analysis is required prior to re-use of recovered refrigerant*
- Remove refrigerant from the system following local and national Codes and Regulations as well as best field practices, including, but not limited to, following:
 - Pump down refrigerant system, if possible (to facilitate recovery process)
 - Make sure that cylinder is situated on the scales before recovery takes place
 - Start the recovery machine and operate in accordance with instructions.
 - Do not overfill cylinders (no more than 80 % volume liquid charge).
 - Do not exceed the maximum working pressure of the cylinder, even temporarily.
 - When the cylinders have been filled correctly and the process completed, make sure that the cylinders and the equipment are removed from site promptly and all isolation valves on the equipment are closed off.
- Once refrigerant is safely and completely recovered, evacuate (vacuum) the system and then break the vacuum by purging the system with dry nitrogen (or other suitable inert gas – no oxygen or air should be used).
 - Ensure that the outlet for the vacuum pump is away from any potential ignition sources, and that proper ventilation is in place.
 - Although not mandatory, it is recommended to repeat last step (evacuate and purge the system).
- Open the system for intended purpose.
 - if repair work involves open flame (brazing etc.)- continuously purge with inert gas
 - If compressors or compressor oils are to be removed, ensure that they have been evacuated to an acceptable level to make certain that flammable refrigerant does not remain within the lubricant. The compressor body shall not be heated by an open flame or other ignition sources to accelerate this process. When oil is drained from a system, it shall be carried out safely.
- If refrigerant recovery is performed for decommissioning purposes or faulty (contaminated, acidic etc.), recovered refrigerant shall not be charged into another REFRIGERATING SYSTEM unless it has been cleaned and checked.

Pools – Equipment Warranty

General Policy

All Dectron service and warranty work is managed exclusively by Dehumidified Air Services (DASV). All warranties apply to the original equipment owner and are not transferable. All warranty inquiries should be made to Dehumidified Air Services.

Dehumidified Air Services:

Phone: 1-833-327-7665 Email: Warranty@DehumidifiedAirServices.com

Dectron warrants as set forth and for the time periods shown below that it will provide through either a DASV Service Technician or an authorized service organization specified and approved by DASV, a new or rebuilt part to replace a factory installed part which has failed because of defect in workmanship or material.

NOTE: EVERY REQUEST RELATED TO WARRANTY OF ANY NATURE AS DESCRIBED BELOW MUST BE OFFICIALLY AUTHORIZED AND DOCUMENTED IN ADVANCE BY DASV TO QUALIFY FOR WARRANTY COVERAGE.

Warranty Void Unless Registered

All Warranties are void unless the start-up of the equipment is approved by a DASV service technician. Upon completion of the start-up, a “Warranty Registration Certificate” will be issued, along with the Start-Up Report, which activates the Warranty Period of the equipment. The Warranty Period will commence either upon completion of start-up registration of the equipment or 6 months from factory ship date, whichever comes first.

Initial 90-Day Comprehensive Warranty

During the first 90 days from initial start-up, all parts and repairs related to factory defects or replacement parts are covered by Dectron manufacturer warranty. All parts and labor requirements will either be handled by DASV technicians directly or managed and approved in advance by DASV through DASV authorized technicians.

Internet Connected, Conditional One Year Repair Warranty

If and only if the equipment is connected to the internet from the date of warranty activation, a Repair Warranty will be provided for an additional 9 months subsequent to the initial 90-Day Comprehensive Warranty for a total of 12 months of parts and labor warranty coverage. The unit must be connected and communicating to Dectron WebSentry for the entire term from start-up in order to qualify.

If qualified, Dectron will provide or pay for the required part and direct labor only, related to the part replacement. Only the labor required to replace the defective part is under warranty for this 9-month extension. Travel time, diagnostic time, per diems, truck charges, shipping charges etc. are not covered under this Conditional Repair Warranty.

Two-Year Parts Warranty

If any factory installed part supplied by Dectron fails because of a defect in workmanship or material prior to the completion of the 24th month from date of completion of the warranty activation, Dectron will provide a new or rebuilt part F.O.B. factory. No labor reimbursement will be made for expenses incurred in replacing the part except as set in the *Initial 90-day Comprehensive or Internet Connected, Conditional One-Year Repair Warranty*.

Dectron reserves the right to have the defective part returned to the factory in order to determine the warranty applicability. Parts shipping and handling costs (to and from the factory) are not covered outside of the *Initial 90-day Warranty*.

Replacement Part Warranty

If a replacement part provided by Dectron under this warranty fails due to a material defect prior to the end of the Two-Year Parts Warranty (or the end of the extended warranty period if applicable), whichever comes first, Dectron will provide a new or rebuilt part F.O.B. factory.

Applicability

This warranty is applicable only to products that are purchased and installed in the United States and Canada. This warranty is NOT applicable to:

1. Products that have become defective or damaged as a result of non-DASV or unauthorized service work, poor maintenance, faulty electrical supply, act of God, or any other circumstances outside of the specified care, maintenance or operation of the equipment including:
 - Components that have been relocated from their original placement during manufacturing.
 - Any portion of the system not supplied by Dectron.
 - Components on which the model and/or serial number plates have been removed or defaced.
 - Components which have become defective or damaged as a result of unauthorized opening of the refrigeration circuit, improper wiring, electrical supply characteristics, poor maintenance, accidents, transportation, misuse, abuse, fire, flood, alteration and/or misapplication of the product.
 - Products not installed, operated and maintained as per the Dectron Operating and Maintenance Manual.
 - Products operating in mechanical rooms that house chemicals (i.e. chlorine, bromine, water treatment chemicals).
 - Products on which payment is in default.

2. Parts that wear out due to normal usage, such as air filters, fuses and sensors are not covered by this warranty.

NOTE: Refrigerant lost during the *Initial 90-day Comprehensive or Internet Connected, Conditional One-Year Repair Warranty* will be reimbursed in accordance to the current market price of refrigerant at the time of repair and upon discretion of DASV's Customer Support team. Dectron will not be responsible for refrigerant lost from the system due to improperly installed contractor piping to the remote outdoor air-cooled condenser.

Limitations

1. DASV is a Manufacturer Service organization, not a first-response or urgent response local service company. As such, we highly recommend that equipment owners have a relationship with their own qualified first response service organization or one recommended by DASV.

DASV hours of operation are from 8:00 AM to 6:00 PM Eastern, Monday through Friday unless otherwise agreed to under a separate agreement.

Parts replacement can be subject to availability. We highly recommend for mission-critical applications that owners purchase and maintain a local stock of critical components in case immediate replacement be required. If for any reason one of those components is replaced under applicable warranty conditions, Dectron will reimburse the original cost of any component used under terms of Warranty.

NOTE: Dectron expressly disclaims any liability for parts replacement delays due to parts unavailability or shipping delays.

2. This warranty is given in lieu of all other warranties. Anything in the warranty notwithstanding, any implied warranties of fitness for particular purpose and merchantability shall be limited to the duration of the warranties described above. Dectron expressly disclaims and excludes any liability for consequential or incidental damage for breach of any express or implied warranty.

Where a jurisdiction does not allow limitations or exclusions in a warranty, the foregoing limitations and exclusions shall not apply to the extent of the legislation, however, in such case the balance of the above warranty shall remain in full force and effect.

This warranty gives specific legal rights. Other rights may vary according to local legislation.

Force Majeure

Dectron will not be liable for delay or failure to provide warranty service due to government restrictions or restraints, war, strikes, material shortages, acts of God or other causes beyond Dectron control.

Optional Extended Warranties

If purchased prior to shipment and documented with a registered extended warranty statement certificate, Dectron will provide replacement components within the specified period of the extended warranties. Extended warranties commence either upon completion of start-up registration of the equipment or 6 months from factory ship date, whichever comes first, and cover parts replacement only for parts that fail as a result of manufacturing defect. The failed parts must be returned to the factory with transportation prepaid by the customer as a condition of these warranties. Optional extended warranties are for parts only and subject to all the terms of the Two-Year Parts Warranty.

1. Optional Five-Year Compressor Warranty

Subject to the terms above, Dectron will provide a replacement compressor for up to 60 months from the date of the warranty activation.

2. Optional Five-Year Dehumidifier Coil Warranty

Subject to the terms above, Dectron will provide a replacement coil for up to 60 months from the date of the warranty activation. Extended coil warranties are for parts of the dehumidifier only and does not cover parts of dry cooler or OACC coils.

3. Optional Ten Year Dehumidifier Coil Warranty

Subject to the terms above, Dectron will provide a replacement coil for up to 120 months from the date of the warranty activation. Extended coil warranties are for parts of the dehumidifier only and does not cover parts of dry cooler or OACC coils.

4. Optional Five-Year Driveline Warranty

Subject to the terms above, Dectron will provide driveline replacement parts for up to 60 months from the date of the warranty activation.

Driveline Components Include:

- Supply fan motor
- Exhaust fan motor (including Min Exhaust and Purge Exhaust motors)
- Heat recovery loop pump
- Compressor glycol/water pump
- Dry cooler/outdoor condenser fan(s)
- Dry cooler pump(s)